

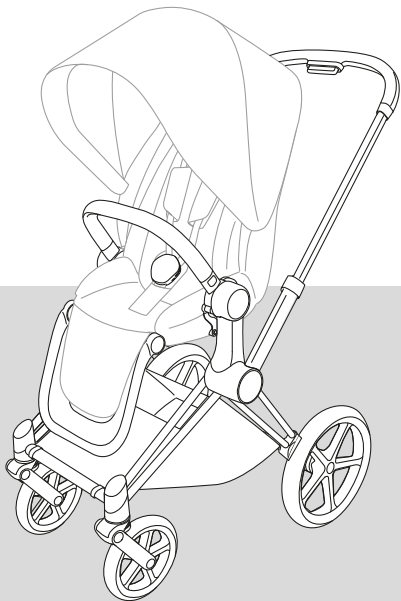

# **PRIAM**

## **FRAME & SEAT**





**EN** WARNING  
**DE** WARNUNG  
**ES** ADVERTENCIA  
**FR** AVERTISSEMENT  
**PT** AVISOS  
**IT** WARNING  
**NL** WAARSCHUWING  
**PL** OSTRZEŻENIE  
**CS** UPOZORNĚNÍ  
**SK** UPOZORNENIE  
**SL** OPOZORILO  
**HR** UPOZORENJE  
**HU** FIGYELMEZTETÉS  
**SE** VARNING  
**NO** ADVARSEL  
**FI** VAROITUS  
**DA** ADVARSEL  
**ET** HOIATUS  
**LV** BRĪDINĀJUMS  
**LT** PERSPĖJIMAS  
**RU** ВНИМАНИЕ  
**UK** УВАГА  
**TR** UYARI  
**EL** ΠΡΟΕΙΔΟΠΟΙΗΣΗ  
**RO** AVERTISMENTE  
**IS** VIÐVÖRUN  
**MT** TWISSIJA

**HE**  
**AR**  
**FA**  
**YUE** 警告  
**CMN** 警告  
**JA** 警告  
**KO** 경고  
**BG** ПРЕДУПРЕЖДЕНИЕ  
**SR** UPOZORENJE  
**MS** AMARAN  
**HI** चेतावनी  
**TH** คำเตือน  
**SQ** PARALAJMËRIM  
**BS** UPOZORENJE  
**ME** UPOZORENJE  
**MK** ПРЕДУПРЕДУВАЊЕ  
**HY** շօղախոսք  
**VI** CẢNH BÁO

אזהרה  
تحذير  
اخطار



**EN** Tutorial video  
**DE** Videoanleitung  
**ES** Tutorial en vídeo  
**FR** Vidéo de démonstration  
**PT** Video tutorial  
**IT** Video tutorial  
**NL** Instructievideo  
**PL** Film instruktażowy  
**CS** Výukové video  
**SK** Výukové video  
**SL** Video z navodili  
**HR** Video s uputama  
**HU** Bemutatóvideó  
**SE** Videosjälvstudiekurs  
**NO** Opplæringsvideo  
**FI** Opetusvideo  
**DA** Vejledende video  
**ET** Õppevideo  
**LV** Arpmācību video  
**LT** Mokomasis vaizdo įrašas  
**RU** Обучающее видео  
**UK** Навчальне відео  
**TR** Öğretici video  
**EL** Εκπαιδευτικό βίντεο  
**RO** Video tutorial  
**IS** Kennslumyndband  
**MT** Tutorial fuq vidjow

**HE**  
**AR**  
**FA**  
**YUE** 教程視頻  
**CMN** 教程视频  
**JA** チュートリアルビデオ  
**KO** 튜토리얼 동영상  
**BG** Учебно видео  
**SR** Video sa uputstvima  
**MS** Video tutorial  
**HI** त्यूटोरियल वीडियो  
**TH** วีดีโอแนะนำ  
**SQ** Video udhëzuese  
**BS** Video sa uputstvima  
**ME** Video sa uputstvima  
**MK** Видеоупатство  
**HY** Παιδαγωγικά βίντεο  
**VI** Video hướng dẫn

ורטון הדרכה  
فیدئو تعلیمی  
ویدئوی آموزشی



**EN** Maximum weights  
**DE** Maximalgewichte  
**ES** Pesos máximos  
**FR** Poids maximum  
**PT** Pesos máximos  
**IT** Peso massimo  
**NL** Maximumgewicht  
**PL** Dopuszczalna waga  
**CS** Maximální hmotnosti  
**SK** Maximálne hmotnosti  
**SL** Največje teže  
**HR** Maksimalne težine  
**HU** Maximális súlyok  
**SE** Max.vikter  
**NO** Maksimumsvektor  
**FI** Enimmäispainot  
**DA** Maksimumvægt  
**ET** Maksimaalne kaal  
**LV** Maksimālais svars  
**LT** Didžiausi svoriai  
**RU** Максимальная масса  
**UK** Максимальна вага  
**TR** Maksimum ağırlıklar

**EL** Μέγιστο βάρος  
**RO** Greutăți maxime  
**IS** Hámarksþyngd  
**MT** Piżijiet massimi  
**HE** משקלים מרביים  
**AR** الأوزان القصوى  
**FA** حداکثر وزن  
**YUE** 最大重量  
**CMN** 最大重量  
**JA** 最大重量  
**KO** 최대 하중  
**BG** Максимални тегла  
**SR** Maksimalne težine  
**MS** Berat maksimum  
**HI** अधिकतम वजन  
**TH** น้ำหนักสูงสุด  
**SQ** Peshat maksimale  
**BS** Maksimalne težine  
**ME** Maksimalne težine  
**MK** Максимални тежини  
**HY** Առավելագույն քաշեր  
**VI** Các mức cân nặng tối đa



**EN** Product registration  
**DE** Produktregistrierung  
**ES** Registro del producto  
**FR** Enregistrement du produit  
**PT** Registo do produto  
**IT** Registrazione del prodotto  
**NL** Productregistratie  
**PL** Rejestracja produktu  
**CS** Registrace výrobku  
**SK** Registrácia výrobku  
**SL** Registracija izdelka  
**HR** Registracija proizvoda  
**HU** Termékregisztráció  
**SE** Produktregistrering  
**NO** Produktregistrering  
**FI** Tuotteen rekisteröinti  
**DA** Produktregistrering  
**ET** Toote registreerimine  
**LV** Produkta reģistrācija  
**LT** Gaminio registracija  
**RU** Регистрация продукта  
**UK** Реєстрація продукту  
**TR** Ürün kaydı

**EL** Καταχώριση προϊόντος  
**RO** Înregistrarea produsului  
**IS** Skráning tækis  
**MT** Reġistrazzjoni tal-prodott  
**HE** רישום המוצר  
**AR** تسجيل المنتج  
**FA** ثبت محصول  
**YUE** 產品註冊  
**CMN** 产品注册  
**JA** 製品の登録  
**KO** 제품 등록  
**BG** Регистрация на продукта  
**SR** Registracija proizvoda  
**MS** Pendaftaran produk  
**HI** उत्पाद पंजीकरण  
**TH** การลงทะเบียนผลิตภัณฑ์  
**SQ** Regjistrimi i produktit  
**BS** Registracija proizvoda  
**ME** Registracija proizvoda  
**MK** Регистрација на производ  
**HY** Արտադրանքի գրանցում  
**VI** Đăng ký sản phẩm

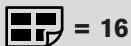

= 16

|           |                |            |                 |
|-----------|----------------|------------|-----------------|
| <b>EN</b> | Set up         | <b>EL</b>  | Στήσιμο         |
| <b>DE</b> | Aufbau         | <b>RO</b>  | Setare          |
| <b>ES</b> | Instalación    | <b>IS</b>  | Uppsetning      |
| <b>FR</b> | Montage        | <b>MT</b>  | Konfigurazzjoni |
| <b>PT</b> | Preparação     | <b>HE</b>  | התקנה           |
| <b>IT</b> | Configurazione | <b>AR</b>  | تنصيب           |
| <b>NL</b> | Opbouw         | <b>FA</b>  | برپا کردن       |
| <b>PL</b> | Montaż         | <b>YUE</b> | 設置              |
| <b>CS</b> | Nastavení      | <b>CMN</b> | 设置              |
| <b>SK</b> | Nastavenie     | <b>JA</b>  | セットアップ          |
| <b>SL</b> | Nastavitev     | <b>KO</b>  | 설정              |
| <b>HR</b> | Postavljanje   | <b>BG</b>  | Настройка       |
| <b>HU</b> | Felszerelés    | <b>SR</b>  | Postavljanje    |
| <b>SE</b> | Inställning    | <b>MS</b>  | Persediaan      |
| <b>NO</b> | Oppsett        | <b>HI</b>  | सेट अप          |
| <b>FI</b> | Asennus        | <b>TH</b>  | การติดตั้ง      |
| <b>DA</b> | Opsætning      | <b>SQ</b>  | Konfigurimi     |
| <b>ET</b> | Seadistamine   | <b>BS</b>  | Postavljanje    |
| <b>LV</b> | Uzstādīšana    | <b>ME</b>  | Postavljanje    |
| <b>LT</b> | Nuostatos      | <b>MK</b>  | Поставување     |
| <b>RU</b> | Установка      | <b>HY</b>  | Շարժափոխում     |
| <b>UK</b> | Встановлення   | <b>VI</b>  | Cài đặt         |
| <b>TR</b> | Kurulum        |            |                 |

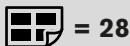

= 28

|           |          |            |             |
|-----------|----------|------------|-------------|
| <b>EN</b> | Brake    | <b>EL</b>  | Φρένα       |
| <b>DE</b> | Bremse   | <b>RO</b>  | Frână       |
| <b>ES</b> | Freno    | <b>IS</b>  | Bremsa      |
| <b>FR</b> | Frein    | <b>MT</b>  | Brejk       |
| <b>PT</b> | Bloqueio | <b>HE</b>  | בלם         |
| <b>IT</b> | Freno    | <b>AR</b>  | المكابح     |
| <b>NL</b> | Rem      | <b>FA</b>  | ترمز        |
| <b>PL</b> | Hamulec  | <b>YUE</b> | 剎車          |
| <b>CS</b> | Brzda    | <b>CMN</b> | 刹车          |
| <b>SK</b> | Brzda    | <b>JA</b>  | ブレーキ        |
| <b>SL</b> | Zavora   | <b>KO</b>  | 브레이크        |
| <b>HR</b> | Kočnica  | <b>BG</b>  | Спирачка    |
| <b>HU</b> | Fék      | <b>SR</b>  | Kočnica     |
| <b>SE</b> | Broms    | <b>MS</b>  | Brek        |
| <b>NO</b> | Brems    | <b>HI</b>  | ब्रेक       |
| <b>FI</b> | Jarru    | <b>TH</b>  | เบรค        |
| <b>DA</b> | Bremse   | <b>SQ</b>  | Frenat      |
| <b>ET</b> | Pidur    | <b>BS</b>  | Kočnica     |
| <b>LV</b> | Bremze   | <b>ME</b>  | Kočnica     |
| <b>LT</b> | Stabdys  | <b>MK</b>  | Сопирачка   |
| <b>RU</b> | Тормоза  | <b>HY</b>  | Արգելակ     |
| <b>UK</b> | Гальма   | <b>VI</b>  | Phanh thắng |
| <b>TR</b> | Fren     |            |             |



 = 29

**EN** Folding  
**DE** Faltung  
**ES** Plegado  
**FR** Pliant  
**PT** Fecho  
**IT** Ripiegamento  
**NL** Vouwen  
**PL** Składanie  
**CS** Skládání  
**SK** Zloženie  
**SL** Zlaganje  
**HR** Preklapanje  
**HU** Összecsukás  
**SE** Ihopfällning  
**NO** Sammenlegging  
**FI** Kokoon taittaminen  
**DA** Sammenklapning  
**ET** Kokkuvoltimine  
**LV** Salocīšana  
**LT** Lankstymas  
**RU** Складывание  
**UK** Складання  
**TR** Katlama

**EL** Αναδίπλωση  
**RO** Pliere  
**IS** Brjótta saman  
**MT** Tiwi  
**HE**  
**AR**  
**FA**  
**YUE** 折疊  
**CMN** 折疊  
**JA** 折りたたみ  
**KO** 접기  
**BG** Сгъване  
**SR** Preklapanje  
**MS** Lipat  
**HI** फोल्डिंग  
**TH** การพับ  
**SQ** Palosja  
**BS** Preklapanje  
**ME** Preklapanje  
**MK** Склопување  
**HY** Ծախելը  
**VI** Gập lại

קיפול  
 قابلة للطي  
 تا کردن



 = 31

**EN** Harness  
**DE** Gurtsystem  
**ES** Arnés  
**FR** Harnais  
**PT** Arnês  
**IT** Imbracatura  
**NL** Harnas  
**PL** Szelki  
**CS** Popruh  
**SK** Popruh  
**SL** Varnostni pas  
**HR** Sustav vezivanja  
**HU** Biztonsági öv  
**SE** Sele  
**NO** Beltesystem  
**FI** Vyöjärjestelmä  
**DA** Selesystem  
**ET** Turvarihmad  
**LV** Drošības josta  
**LT** Diržai  
**RU** Ремни безопасности  
**UK** Ремінь  
**TR** Emniyet kemeri

**EL** Συγκράτηση  
**RO** Centură  
**IS** Beisli  
**MT** Ċinga tas-sigurtà  
**HE**  
**AR**  
**FA**  
**YUE** 安全帶  
**CMN** 安全帶  
**JA** 安全ベルト  
**KO** 하네스  
**BG** Сбруя  
**SR** Sistem vezivanja  
**MS** Abah-abah  
**HI** कबच  
**TH** ระบบสายรัด  
**SQ** Pajimet  
**BS** Sistem vezivanja  
**ME** Sistem vezivanja  
**MK** Сигурносен каиш  
**HY** Ամրագրուի  
**VI** Dây an toàn

התמה  
 طقم التشد  
 سيستم مهار



= 34

|           |                         |            |                         |
|-----------|-------------------------|------------|-------------------------|
| <b>EN</b> | Two wheel mode          | <b>EL</b>  | Λειτουργία δύο τροχών   |
| <b>DE</b> | Zweirad-Modus           | <b>RO</b>  | Mod cu două roți        |
| <b>ES</b> | Modo de dos ruedas      | <b>IS</b>  | Stilling fyrir tvö hjól |
| <b>FR</b> | Mode deux roues         | <b>MT</b>  | Modalità b'żewġ roti    |
| <b>PT</b> | Modo de duas rodas      | <b>HE</b>  | מצב דו-גלגלי            |
| <b>IT</b> | Modalità a due ruote    | <b>AR</b>  | وضع العجلتين            |
| <b>NL</b> | Tweewiel-modus          | <b>FA</b>  | حالت دوچرخ              |
| <b>PL</b> | Typ dwukołowy           | <b>YUE</b> | 兩輪模式                    |
| <b>CS</b> | Režim dvou kol          | <b>CMN</b> | 两轮模式                    |
| <b>SK</b> | Dvojkolesový režim      | <b>JA</b>  | 2輪モード                   |
| <b>SL</b> | Dvokolesni način        | <b>KO</b>  | 두 휠 모드                  |
| <b>HR</b> | Režim rada s dva kotača | <b>BG</b>  | Режим с две колела      |
| <b>HU</b> | Kétkerék mód            | <b>SR</b>  | Režim rada na dva točka |
| <b>SE</b> | Tvåhjulsläge            | <b>MS</b>  | Mod dua roda            |
| <b>NO</b> | Tohjulmodus             | <b>HI</b>  | दो पहिया मोड            |
| <b>FI</b> | Kaksipyöräinen tila     | <b>TH</b>  | โหมดสองล้อ              |
| <b>DA</b> | Tohjulstilstand         | <b>SQ</b>  | Modaliteti me dy rrota  |
| <b>ET</b> | Kahe ratta režiim       | <b>BS</b>  | Režim rada na dva točka |
| <b>LV</b> | Divu riteņu režīms      | <b>ME</b>  | Režim rada na dva točka |
| <b>LT</b> | Dviejų ratų režimas     | <b>MK</b>  | Режим за две тркала     |
| <b>RU</b> | Двухколесный режим      | <b>HY</b>  | Երկսկիլի ռեժիմ          |
| <b>UK</b> | Двоколісний режим       | <b>VI</b>  | Chế độ hai bánh xe      |
| <b>TR</b> | İki tekerlekli mod      |            |                         |

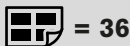

= 36

|           |                         |            |                           |
|-----------|-------------------------|------------|---------------------------|
| <b>EN</b> | Bumper bar              | <b>EL</b>  | Μπάρα διάταξης προστασίας |
| <b>DE</b> | Schutzbügel             | <b>RO</b>  | Bară de protecție         |
| <b>ES</b> | Barra de seguridad      | <b>IS</b>  | Þverbiti                  |
| <b>FR</b> | Barre de protection     | <b>MT</b>  | Strixxa tal-bumper        |
| <b>PT</b> | Barra de segurança      | <b>HE</b>  | סוגי פגיוש                |
| <b>IT</b> | Barra paraurti          | <b>AR</b>  | عازضة ممتص الصدمات        |
| <b>NL</b> | Veiligheidsbeugel       | <b>FA</b>  | مویله ضربیهگیر            |
| <b>PL</b> | Pałak zabezpieczający   | <b>YUE</b> | 保險杠                       |
| <b>CS</b> | Dětské madlo            | <b>CMN</b> | 保险杠                       |
| <b>SK</b> | Detská rúčka            | <b>JA</b>  | バンパー/バー                   |
| <b>SL</b> | Varnostni lok           | <b>KO</b>  | 범퍼 바                      |
| <b>HR</b> | Štitnik                 | <b>BG</b>  | Броня                     |
| <b>HU</b> | Karfa                   | <b>SR</b>  | Štitnik                   |
| <b>SE</b> | Stötfångare             | <b>MS</b>  | Bar bumper                |
| <b>NO</b> | Fender                  | <b>HI</b>  | बम्पर बार                 |
| <b>FI</b> | Suojakaari              | <b>TH</b>  | แบริกั้นชน                |
| <b>DA</b> | Sikkerhedsbøjle         | <b>SQ</b>  | Shufra e parakolpit       |
| <b>ET</b> | Turvakaar               | <b>BS</b>  | Štitnik                   |
| <b>LV</b> | Aizsargloks             | <b>ME</b>  | Štitnik                   |
| <b>LT</b> | Amortizatoriaus strypas | <b>MK</b>  | Одбојник                  |
| <b>RU</b> | Поручень                | <b>HY</b>  | Թափարգէլ                  |
| <b>UK</b> | Обмежувальний поручень  | <b>VI</b>  | Thanh chống va đập        |
| <b>TR</b> | Tampon çubuğu           |            |                           |



 = 36

|                                 |                                 |
|---------------------------------|---------------------------------|
| <b>EN</b> Seat direction        | <b>EL</b> Κατεύθυνση καθίσματος |
| <b>DE</b> Sitzrichtung          | <b>RO</b> Direcție scaun        |
| <b>ES</b> Dirección de la silla | <b>IS</b> Sætisstefna           |
| <b>FR</b> Sens du siège         | <b>MT</b> Direzzjoni tas-sit    |
| <b>PT</b> Orientação do assento | <b>HE</b> כיוון המושב           |
| <b>IT</b> Direzione di seduta   | <b>AR</b> اتجاه المقعد          |
| <b>NL</b> Zitrichting           | <b>FA</b> جهت صندلی             |
| <b>PL</b> Kierunek siedzenia    | <b>YUE</b> 座椅方向                 |
| <b>CS</b> Směr sedadla          | <b>CMN</b> 座椅方向                 |
| <b>SK</b> Smer sedadla          | <b>JA</b> シートの方向                |
| <b>SL</b> Smer sedeža           | <b>KO</b> 좌석 방향                 |
| <b>HR</b> Smjer sjedala         | <b>BG</b> Посока на седалката   |
| <b>HU</b> Ülésirány             | <b>SR</b> Smer sedišta          |
| <b>SE</b> Sitsriktning          | <b>MS</b> Arah kerusi           |
| <b>NO</b> Seteretning           | <b>HI</b> सीट दिशा              |
| <b>FI</b> Istumasuunta          | <b>TH</b> ทิศทางที่นั่ง         |
| <b>DA</b> Sæderetning           | <b>SQ</b> Drejtimi i ndenjësës  |
| <b>ET</b> Istme suund           | <b>BS</b> Smjer sjedišta        |
| <b>LV</b> Sēdekļa virziens      | <b>ME</b> Smjer sjedišta        |
| <b>LT</b> Kėdutės kryptis       | <b>MK</b> Правец на седиште     |
| <b>RU</b> Направление сиденья   | <b>HY</b> Ստախտեղի ուղղություն  |
| <b>UK</b> Напрямок сидіння      | <b>VI</b> Hướng ghế ngồi        |
| <b>TR</b> Koltuk yönü           |                                 |



 = 37

|                             |                                  |
|-----------------------------|----------------------------------|
| <b>EN</b> Backrest          | <b>EL</b> Πλάτη                  |
| <b>DE</b> Rückenlehne       | <b>RO</b> Spătar                 |
| <b>ES</b> Respaldo          | <b>IS</b> Bak                    |
| <b>FR</b> Dossier           | <b>MT</b> Serħ id-dahar          |
| <b>PT</b> Encosto de costas | <b>HE</b> משענת גב               |
| <b>IT</b> Schienale         | <b>AR</b> مسند الظهر             |
| <b>NL</b> Rugleuning        | <b>FA</b> پشتی                   |
| <b>PL</b> Oparcie           | <b>YUE</b> 靠背                    |
| <b>CS</b> Opěradlo          | <b>CMN</b> 靠背                    |
| <b>SK</b> Operadlo          | <b>JA</b> 背もたれ                   |
| <b>SL</b> Naslonjalo        | <b>KO</b> 등받이                    |
| <b>HR</b> Naslon            | <b>BG</b> Облегалка              |
| <b>HU</b> Háttámla          | <b>SR</b> Naslon                 |
| <b>SE</b> Ryggstöd          | <b>MS</b> Penyangdar belakang    |
| <b>NO</b> Rygglene          | <b>HI</b> बैकरेस्ट               |
| <b>FI</b> Selkänoja         | <b>TH</b> พนักพิง                |
| <b>DA</b> Ryglæn            | <b>SQ</b> Mbështetësja e shpinës |
| <b>ET</b> Seljatugi         | <b>BS</b> Naslon                 |
| <b>LV</b> Atzveltne         | <b>ME</b> Naslon                 |
| <b>LT</b> Nugaros atlošas   | <b>MK</b> Наслон за грб          |
| <b>RU</b> Спинка            | <b>HY</b> Թիվալակ                |
| <b>UK</b> Спинка            | <b>VI</b> Phấn tựa lưng          |
| <b>TR</b> Arkalık           |                                  |





= 37

|           |                   |            |                        |
|-----------|-------------------|------------|------------------------|
| <b>EN</b> | Legrest           | <b>EL</b>  | Στήριγμα ποδιών        |
| <b>DE</b> | Beinstütze        | <b>RO</b>  | Support picior         |
| <b>ES</b> | Reposapiés        | <b>IS</b>  | Fótahvíla              |
| <b>FR</b> | Repose-pieds      | <b>MT</b>  | Serħ is-saqajn         |
| <b>PT</b> | Apoio de pernas   | <b>HE</b>  | משענת רגליים           |
| <b>IT</b> | Poggiagambe       | <b>AR</b>  | ميسند الساق            |
| <b>NL</b> | Beensteun         | <b>FA</b>  | جاپادی                 |
| <b>PL</b> | Podnózek          | <b>YUE</b> | 腿托                     |
| <b>CS</b> | Opěrka nohou      | <b>CMN</b> | 腿托                     |
| <b>SK</b> | Opierka nôh       | <b>JA</b>  | 足のせ                    |
| <b>SL</b> | Naslon za noge    | <b>KO</b>  | 다리받이                   |
| <b>HR</b> | Naslon za noge    | <b>BG</b>  | Подложка за крака      |
| <b>HU</b> | Lábtartó          | <b>SR</b>  | Naslon za noge         |
| <b>SE</b> | Benstöd           | <b>MS</b>  | Tempat letak kaki      |
| <b>NO</b> | Benstøtte         | <b>HI</b>  | लेगरेस्ट               |
| <b>FI</b> | Jalkatuki         | <b>TH</b>  | ที่วางขา               |
| <b>DA</b> | Benstøtte         | <b>SQ</b>  | Mbështetësja e këmbëve |
| <b>ET</b> | Jalatugi          | <b>BS</b>  | Naslon za noge         |
| <b>LV</b> | Kāju balsts       | <b>ME</b>  | Naslon za noge         |
| <b>LT</b> | Kojų atrama       | <b>MK</b>  | Наслон за носе         |
| <b>RU</b> | Подставка для ног | <b>HY</b>  | Ուղեքրի հեւման կէտն    |
| <b>UK</b> | Опора для ніг     | <b>VI</b>  | Phàn tựa chân          |
| <b>TR</b> | Bacak desteği     |            |                        |



= 38

|           |                                |            |                       |
|-----------|--------------------------------|------------|-----------------------|
| <b>EN</b> | Sun canopy                     | <b>EL</b>  | Κουκούλα για τον ήλιο |
| <b>DE</b> | Sonnenverdeck                  | <b>RO</b>  | Copertină             |
| <b>ES</b> | Capota para el sol             | <b>IS</b>  | Sólartjald            |
| <b>FR</b> | Pare-soleil                    | <b>MT</b>  | Kopertura mix-xemx    |
| <b>PT</b> | Capota solar                   | <b>HE</b>  | סמטת שמש              |
| <b>IT</b> | Parasole                       | <b>AR</b>  | مظلة الشمس            |
| <b>NL</b> | Zonnekap                       | <b>FA</b>  | سایبان                |
| <b>PL</b> | Oslona przeciwsłoneczna        | <b>YUE</b> | 遮陽篷                   |
| <b>CS</b> | Stříška proti slunci           | <b>CMN</b> | 遮阳篷                   |
| <b>SK</b> | Strieška proti slnku           | <b>JA</b>  | 日よけ力バー                |
| <b>SL</b> | Senčnik za zaščito pred soncem | <b>KO</b>  | 선 캐노피                 |
| <b>HR</b> | Tenda za sunce                 | <b>BG</b>  | Тента                 |
| <b>HU</b> | Kupola                         | <b>SR</b>  | Tenda za sunce        |
| <b>SE</b> | Solsufflett                    | <b>MS</b>  | Kanopi matahari       |
| <b>NO</b> | Solskjerm                      | <b>HI</b>  | शुप छतरी              |
| <b>FI</b> | Aurinkokatos                   | <b>TH</b>  | หลังคาบังแดด          |
| <b>DA</b> | Solkaleche                     | <b>SQ</b>  | Strea për diellin     |
| <b>ET</b> | Päikesevari                    | <b>BS</b>  | Tenda za sunce        |
| <b>LV</b> | Saules aizsegs                 | <b>ME</b>  | Tenda za sunce        |
| <b>LT</b> | Stogelis nuo saulės            | <b>MK</b>  | Стреа за сонце        |
| <b>RU</b> | Солнцезащитный козырек         | <b>HY</b>  | Արևապաշտպան ծածկ      |
| <b>UK</b> | Тент від сонця                 | <b>VI</b>  | Mái che nắng          |
| <b>TR</b> | Güneş başlığı                  |            |                       |

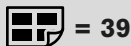

|           |                    |
|-----------|--------------------|
| <b>EN</b> | Handle bar         |
| <b>DE</b> | Schiebegriff       |
| <b>ES</b> | Manillar           |
| <b>FR</b> | Poignée de poussée |
| <b>PT</b> | Guiador            |
| <b>IT</b> | Manubrio           |
| <b>NL</b> | Duwstang           |
| <b>PL</b> | Uchwyt             |
| <b>CS</b> | Madlo              |
| <b>SK</b> | Rukováť            |
| <b>SL</b> | Ročaj              |
| <b>HR</b> | Ručice             |
| <b>HU</b> | Tolókar            |
| <b>SE</b> | Handtag            |
| <b>NO</b> | Håndtak            |
| <b>FI</b> | Työntökahva        |
| <b>DA</b> | Styr               |
| <b>ET</b> | Sang               |
| <b>LV</b> | Rokturis           |
| <b>LT</b> | Rankena            |
| <b>RU</b> | Рукоятка           |
| <b>UK</b> | Рукоятка           |
| <b>TR</b> | Tutma sapı         |

|            |                  |
|------------|------------------|
| <b>EL</b>  | Ράβρος λαβής     |
| <b>RO</b>  | Mâner            |
| <b>IS</b>  | Handfang         |
| <b>MT</b>  | Handle bar       |
| <b>HE</b>  | מוט דחיפה        |
| <b>AR</b>  | عارضة المقبض     |
| <b>FA</b>  | میله دسته        |
| <b>YUE</b> | 把手               |
| <b>CMN</b> | 把手               |
| <b>JA</b>  | ハンドルバー           |
| <b>KO</b>  | 핸들 바             |
| <b>BG</b>  | Кормило          |
| <b>SR</b>  | Ručke            |
| <b>MS</b>  | Bar pemegang     |
| <b>HI</b>  | हैंडल बार        |
| <b>TH</b>  | ด้ามจับ          |
| <b>SQ</b>  | Shufra e dorezës |
| <b>BS</b>  | Ručice           |
| <b>ME</b>  | Ručke            |
| <b>MK</b>  | Рачка            |
| <b>HY</b>  | Կռնափարման բռնակ |
| <b>VI</b>  | Tay cãm          |



|           |                         |
|-----------|-------------------------|
| <b>EN</b> | Swivel locks            |
| <b>DE</b> | Schwenkradsperre        |
| <b>ES</b> | Bloqueos de dirección   |
| <b>FR</b> | Verrous pivotants       |
| <b>PT</b> | Bloqueios de rotação    |
| <b>IT</b> | Blocchi girevoli        |
| <b>NL</b> | Zwenkvergrendeling      |
| <b>PL</b> | Blokada obrotu          |
| <b>CS</b> | Aretační zámky          |
| <b>SK</b> | Aretačné zámky          |
| <b>SL</b> | Blokada vrtenja         |
| <b>HR</b> | Zaključavanje okretanja |
| <b>HU</b> | Beállás-zár             |
| <b>SE</b> | Vridlås                 |
| <b>NO</b> | Svingelåser             |
| <b>FI</b> | Kääntölukko             |
| <b>DA</b> | Drejelås                |
| <b>ET</b> | Pöördlukustus           |
| <b>LV</b> | Rotācijas bloķētāji     |
| <b>LT</b> | Šarnyriniai fiksatoriai |
| <b>RU</b> | Блокировки вращения     |
| <b>UK</b> | Замок шарніра           |
| <b>TR</b> | Tekerlek kilidi         |

|            |                            |
|------------|----------------------------|
| <b>EL</b>  | Περιστροφόμενες κλειδαριές |
| <b>RO</b>  | Încuietori pivotante       |
| <b>IS</b>  | Snúningslásar              |
| <b>MT</b>  | Lokks li jduru             |
| <b>HE</b>  | נעילת סיבוב                |
| <b>AR</b>  | أقفال دوران العجلات        |
| <b>FA</b>  | قفل های نوسان              |
| <b>YUE</b> | 旋轉鎖                        |
| <b>CMN</b> | 旋轉鎖                        |
| <b>JA</b>  | 回転ロック                      |
| <b>KO</b>  | 회전 잠금장치                    |
| <b>BG</b>  | Завъртащи се ключалки      |
| <b>SR</b>  | Zakretni mehanizmi         |
| <b>MS</b>  | Kunci ayun                 |
| <b>HI</b>  | कुंडा ताले                 |
| <b>TH</b>  | ตัวล็อกแบบหมุน             |
| <b>SQ</b>  | Kuçja e rrotave            |
| <b>BS</b>  | Zakretni mehanizmi         |
| <b>ME</b>  | Zakretni mehanizmi         |
| <b>MK</b>  | Заклучување на тркалата    |
| <b>HY</b>  | Պտտվողի կողպիչներ          |
| <b>VI</b>  | Khóa xoay                  |

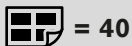

|           |                       |            |                          |
|-----------|-----------------------|------------|--------------------------|
| <b>EN</b> | Removing the wheels   | <b>EL</b>  | Αφαίρεση των τροχών      |
| <b>DE</b> | Entfernen der Räder   | <b>RO</b>  | Îndepărtarea roților     |
| <b>ES</b> | Quitar las ruedas     | <b>IS</b>  | Fjarlægja hjól           |
| <b>FR</b> | Retrait des roues     | <b>MT</b>  | Tneħhija tar-roti        |
| <b>PT</b> | Remover as rodas      | <b>HE</b>  | הסרת הגלגלים             |
| <b>IT</b> | Rimozione delle ruote | <b>AR</b>  | فك العجلات               |
| <b>NL</b> | De wielen verwijderen | <b>FA</b>  | باز کردن چرخ‌ها          |
| <b>PL</b> | Zdejmowanie kółek     | <b>YUE</b> | 拆卸車輪                     |
| <b>CS</b> | Odstranění koleček    | <b>CMN</b> | 拆卸车轮                     |
| <b>SK</b> | Odstránenie koliesok  | <b>JA</b>  | 車輪の取り外し                  |
| <b>SL</b> | Odstranjevanje koles  | <b>KO</b>  | 휠 제거                     |
| <b>HR</b> | Uklanjanje kotača     | <b>BG</b>  | Демонтиране на колелата  |
| <b>HU</b> | Kerekek eltávolítása  | <b>SR</b>  | Uklanjanje točkova       |
| <b>SE</b> | Ta bort hjulen        | <b>MS</b>  | Menanggalkan roda        |
| <b>NO</b> | Fjerne hjulene        | <b>HI</b>  | फहियों को हटाना          |
| <b>FI</b> | Pyörien poisto        | <b>TH</b>  | การถอดล้อ                |
| <b>DA</b> | Fjernelse af hjulene  | <b>SQ</b>  | Heqja e rrotave          |
| <b>ET</b> | Rataste eemaldamine   | <b>BS</b>  | Uklanjanje točkova       |
| <b>LV</b> | Riteņu atvienošana    | <b>ME</b>  | Uklanjanje točkova       |
| <b>LT</b> | Ratų nuėmimas         | <b>MK</b>  | Отстранување на тркалата |
| <b>RU</b> | Снятие колес          | <b>HY</b>  | Անհիվանքը հանելը         |
| <b>UK</b> | Зняття коліс          | <b>VI</b>  | Tháo bánh xe             |
| <b>TR</b> | Tekerlekleri çıkarma  |            |                          |

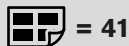

|           |                        |            |                           |
|-----------|------------------------|------------|---------------------------|
| <b>EN</b> | Removing the fabric    | <b>EL</b>  | Αφαίρεση του υφάσματος    |
| <b>DE</b> | Entfernen des Bezuges  | <b>RO</b>  | Îndepărtarea țesăturii    |
| <b>ES</b> | Quitar la tela         | <b>IS</b>  | Fjarlægja efni            |
| <b>FR</b> | Retrait du tissu       | <b>MT</b>  | Tneħhija tad-drapp        |
| <b>PT</b> | Remover o tecido       | <b>HE</b>  | הסרת הבד                  |
| <b>IT</b> | Rimozione del tessuto  | <b>AR</b>  | فك القماش                 |
| <b>NL</b> | De stof verwijderen    | <b>FA</b>  | برداشتن پارچه             |
| <b>PL</b> | Zdejmowanie pokrycia   | <b>YUE</b> | 拆除罩布                      |
| <b>CS</b> | Odstranění látky       | <b>CMN</b> | 拆除罩布                      |
| <b>SK</b> | Odstránenie látky      | <b>JA</b>  | カバーの取り外し                  |
| <b>SL</b> | Odstranjevanje blaga   | <b>KO</b>  | 페브릭 제거                    |
| <b>HR</b> | Uklanjanje tkanine     | <b>BG</b>  | Демонтиране на плата      |
| <b>HU</b> | Huzat eltávolítása     | <b>SR</b>  | Uklanjanje tkanine        |
| <b>SE</b> | Ta bort tyget          | <b>MS</b>  | Menanggalkan fabrik       |
| <b>NO</b> | Fjerne stoffet         | <b>HI</b>  | कपड़ा हटाना               |
| <b>FI</b> | Kankaan poisto         | <b>TH</b>  | การถอดผ้า                 |
| <b>DA</b> | Fjernelse af stoffet   | <b>SQ</b>  | Heqja e copës             |
| <b>ET</b> | Kanga eemaldamine      | <b>BS</b>  | Uklanjanje tkanine        |
| <b>LV</b> | Pārklājuma atvienošana | <b>ME</b>  | Uklanjanje tkanine        |
| <b>LT</b> | Audinio nuėmimas       | <b>MK</b>  | Отстранување на навлаката |
| <b>RU</b> | Снятие ткани           | <b>HY</b>  | Գործվածքը հանելը          |
| <b>UK</b> | Зняття матерії         | <b>VI</b>  | Tháo phần vải bọc         |
| <b>TR</b> | Kilifi çıkarma         |            |                           |



**EN** Carry Cot  
**DE** Kinderwagenaufsatz  
**ES** Capazo  
**FR** Navelle bébé  
**PT** Alcofa  
**IT** Culla portatile  
**NL** Zitbak  
**PL** Gondola wózka dziecięcego  
**CS** Hluboká korba  
**SK** Korba na prenášanie  
**SL** Nosilna košara  
**HR** Ležaljka za prenošenje  
**HU** Mózeskosár  
**SE** Barnvagnslift  
**NO** Babybag  
**FI** Kantolaukku  
**DA** Babylift  
**ET** Vankrikorv  
**LV** Bērnu gultiņa  
**LT** Nešiojamasis lopšys  
**RU** Переносная люлька  
**UK** Переносне дитяче ліжечко  
**TR** Portbebe

**EL** Πορτ-μπεμπέ  
**RO** Landou portabil  
**IS** Burðarrúm  
**MT** Carry Cot  
**HE** ערִיסָה  
**AR** سرير محمول  
**FA** ساک حمل نوزاد  
**YUE** 便攜嬰兒床  
**CMN** 便携嬰兒床  
**JA** 持ち運びベッド  
**KO** 캐리콧  
**BG** Легло за носене  
**SR** Dodatak za kolica  
**MS** Katil Bayi Bimbit  
**HI** कैरी काँट  
**TH** ตะกร้าที่นอนเด็ก  
**SQ** Djep  
**BS** Dodatak za kolica  
**ME** Dodatak za kolica  
**MK** Кошница за носење  
**HY** Սանկալախ  
 շարժական մահճալախ  
**VI** Nôi xách tay

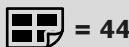

**EN** Infant Car Seat  
**DE** Babyschale  
**ES** Silla infantil para coche  
**FR** Siège auto pour enfant  
**PT** Cadeira auto infantil  
**IT** Seggiolino per auto  
**NL** Autostoeltje  
**PL** Fotelik dla niemowlaka  
**CS** Vajičko  
**SK** Autosedačka pre dojčatá  
**SL** Avtosedež za dojenčke  
**HR** Autosjedalica za bebe  
**HU** Gyermekek autósülés  
**SE** Bilbarnstol  
**NO** Barnebilsete  
**FI** Lasten istuin  
**DA** Autostol  
**ET** Imiku turvatool  
**LV** Zīdaīņu sēdekļis  
**LT** Automobiline naujagimio kėdutė  
**RU** Детское автокресло  
**UK** Автокрісло для немовлят  
**TR** Bebek Araba Koltuğu

**EL** Παιδικό κάθισμα αυτοκινήτου  
**RO** Scaunul auto pentru infant  
**IS** Smábarnabílstóll  
**MT** Sit tal-Karozza tat-Tfal  
**HE** קרֵסֵל לִילָד  
**AR** مقعد سيارة للرضع  
**FA** صندلی خودرو برای نوزاد  
**YUE** 嬰兒汽車座椅  
**CMN** 婴儿汽车座椅  
**JA** 幼児用カーシート  
**KO** 유아용 카시트  
**BG** Бебешка седалка за автомобил  
**SR** Auto sedište za bebe  
**MS** Kerusi Keselamatan Bayi  
**HI** शिशु कार सीट  
**TH** คาร์ซีทสำหรับเด็กทารก  
**SQ** Sexholino  
**BS** Auto sjedište za bebe  
**ME** Auto sjedište za bebe  
**MK** Детско седиште за автомобил  
**HY** Ավտոմոբիլային մանուկային նստատեղի  
**VI** Ghế xe dành cho trẻ sơ sinh

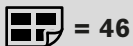

|           |                        |            |                       |
|-----------|------------------------|------------|-----------------------|
| <b>EN</b> | Rain cover             | <b>EL</b>  | Καλύπτρα βροχής       |
| <b>DE</b> | Regenverdeck           | <b>RO</b>  | Prelată de ploaie     |
| <b>ES</b> | Funda para la lluvia   | <b>IS</b>  | Regn yfirbreiðsla     |
| <b>FR</b> | Housse de pluie        | <b>MT</b>  | Għata mix-xita        |
| <b>PT</b> | Capa de chuva          | <b>HE</b>  | דשא 'סו'ס             |
| <b>IT</b> | Parapioggia            | <b>AR</b>  | غطاء المطر            |
| <b>NL</b> | Regenhoes              | <b>FA</b>  | روکش باران            |
| <b>PL</b> | Oslona od deszczu      | <b>YUE</b> | 防雨罩                   |
| <b>CS</b> | Pláštěnka              | <b>CMN</b> | 防雨罩                   |
| <b>SK</b> | Kryt proti dažďu       | <b>JA</b>  | 雨よけ                   |
| <b>SL</b> | Dežna prevleka         | <b>KO</b>  | 레인커버                  |
| <b>HR</b> | Pokrivač za kišu       | <b>BG</b>  | Дъждобран             |
| <b>HU</b> | Esővédő                | <b>SR</b>  | Pokrivač za kišu      |
| <b>SE</b> | Regnskydd              | <b>MS</b>  | Pelindung hujan       |
| <b>NO</b> | Kalesje                | <b>HI</b>  | रेन कवर               |
| <b>FI</b> | Sadesuoja              | <b>TH</b>  | ผ้าคลุมกันฝน          |
| <b>DA</b> | Regnslag               | <b>SQ</b>  | Mbulesë për shiun     |
| <b>ET</b> | Vihmakate              | <b>BS</b>  | Pokrivač za kišu      |
| <b>LV</b> | Pretlietus pārvalks    | <b>ME</b>  | Pokrivač za kišu      |
| <b>LT</b> | Uždangalas nuo lietaus | <b>MK</b>  | Прекривка за дожд     |
| <b>RU</b> | Дождевик               | <b>HY</b>  | Անձրևապաշտպան<br>ծածկ |
| <b>UK</b> | Дошовик                | <b>VI</b>  | Tấm che mưa           |
| <b>TR</b> | Yağmurluk              |            |                       |

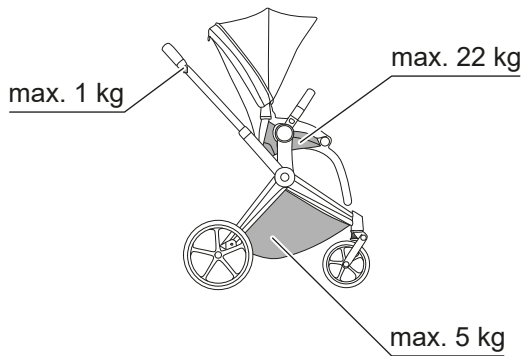

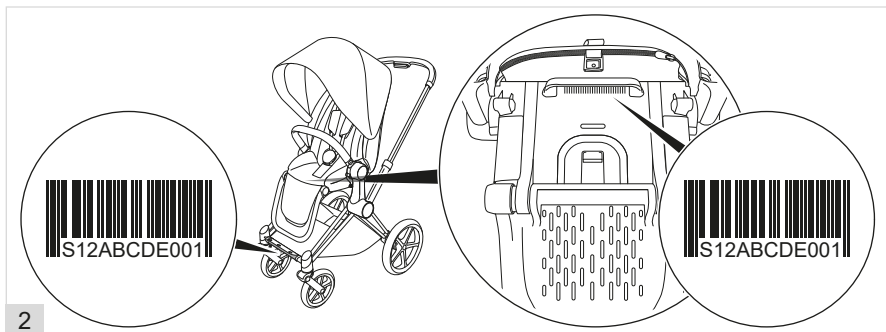
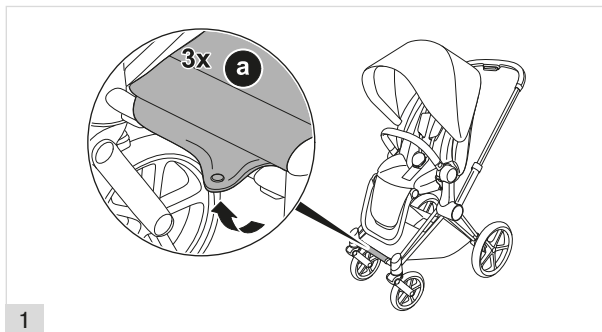

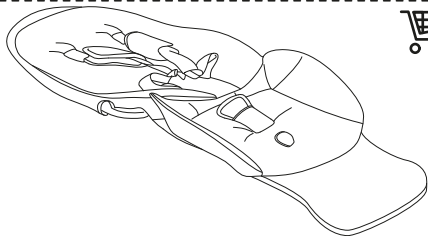
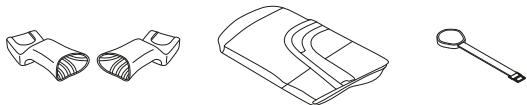
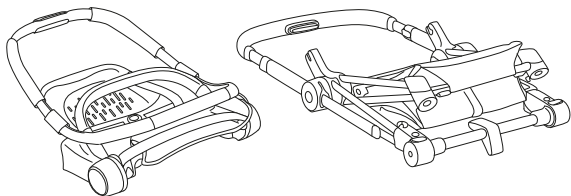



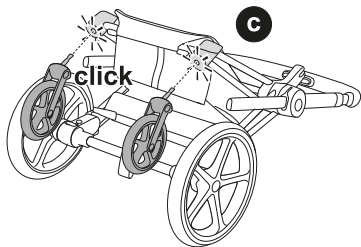
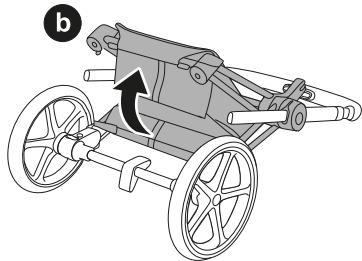
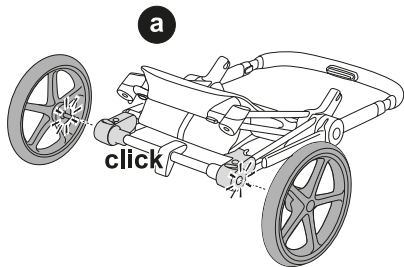

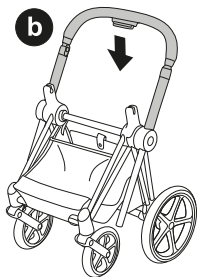
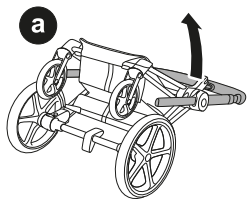

3

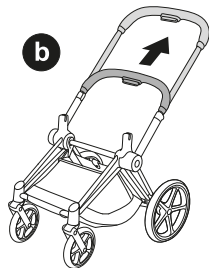
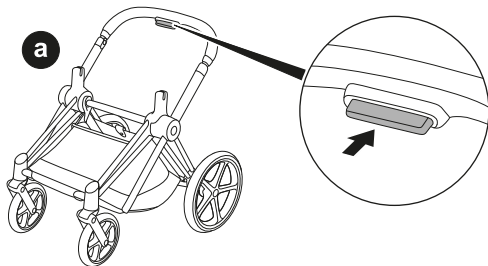

4

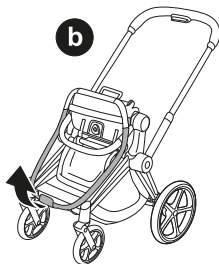
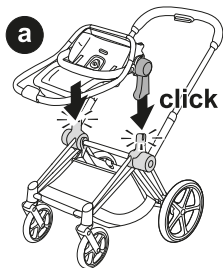

5

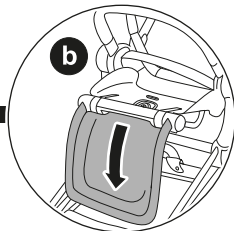
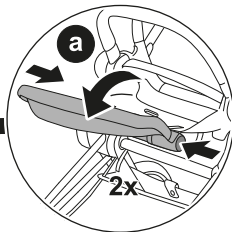
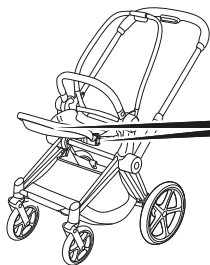

6

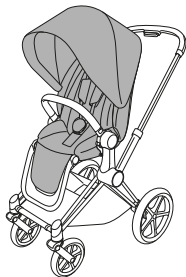

7

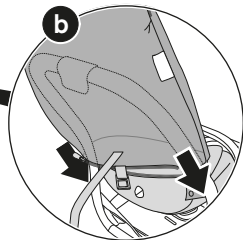
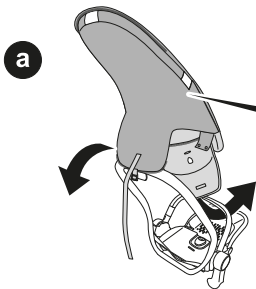

20

8

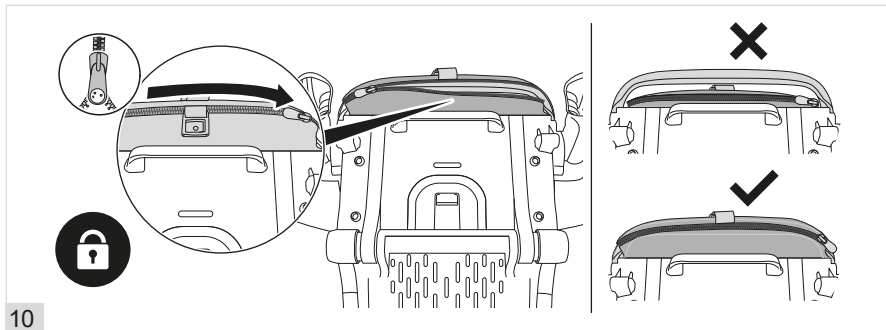
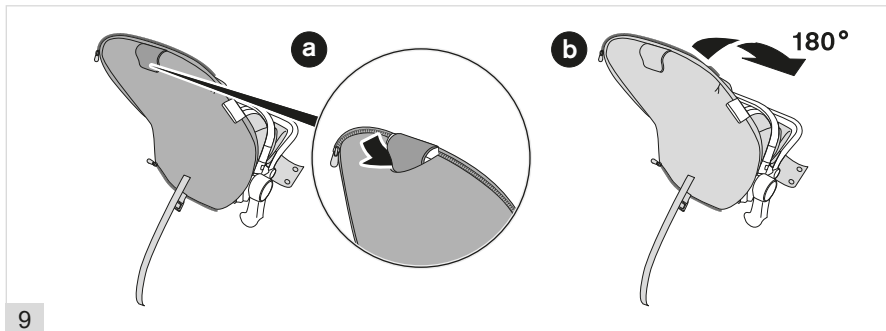

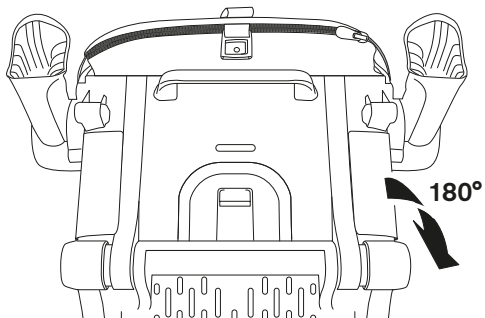
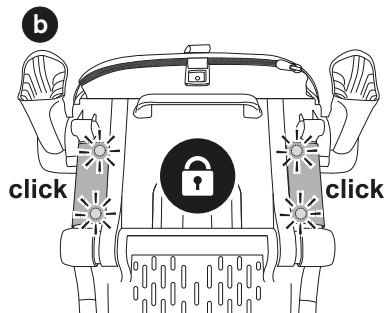
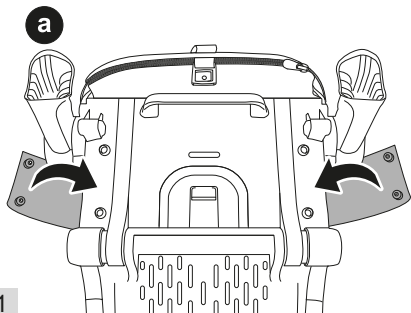

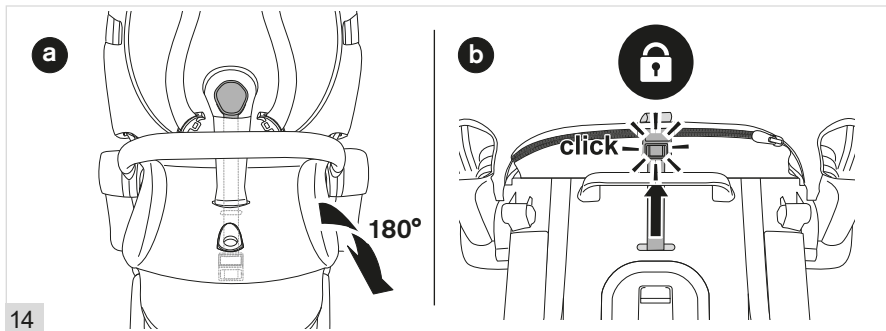
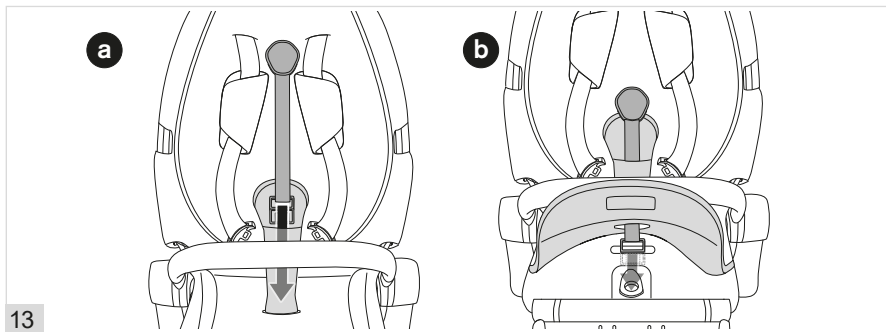

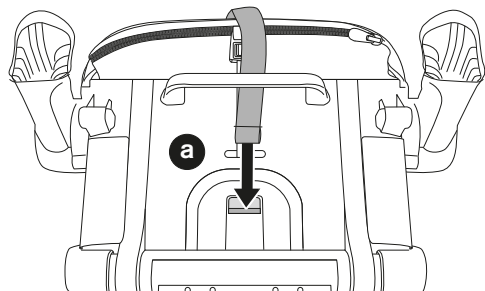

15

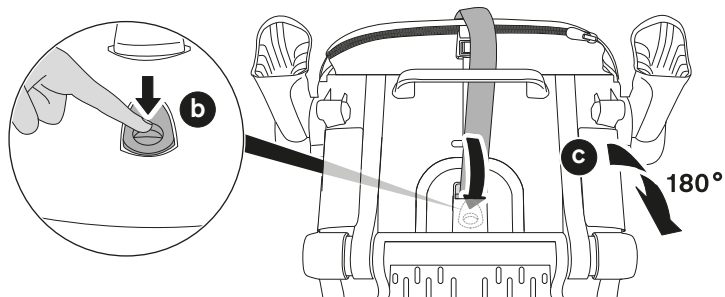

24

16



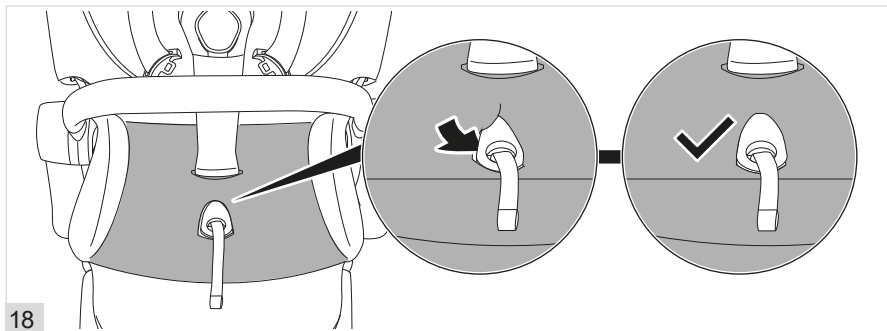
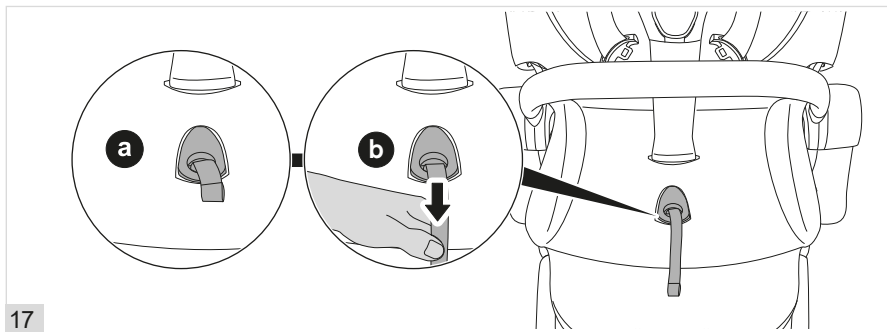

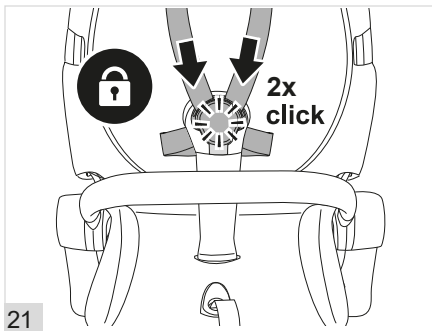
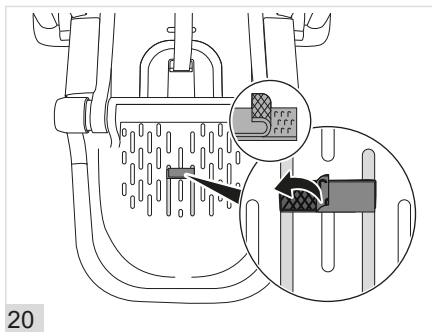
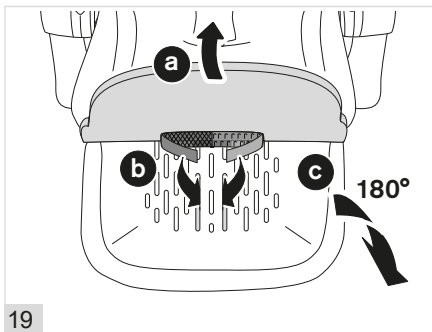

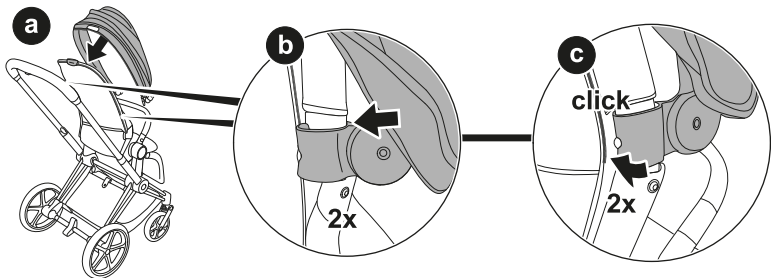

23

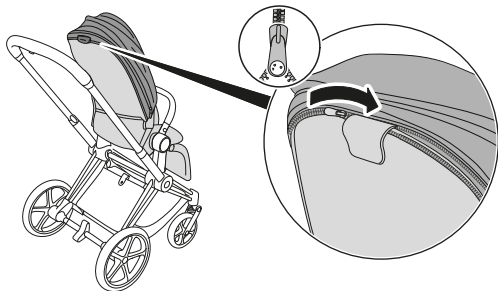

24

27

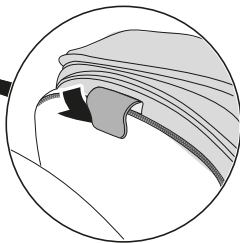
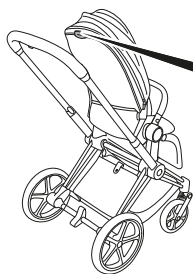

25

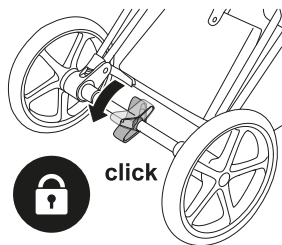
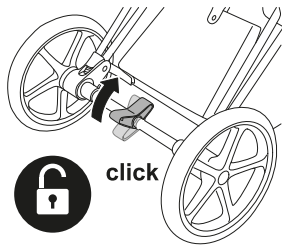

1

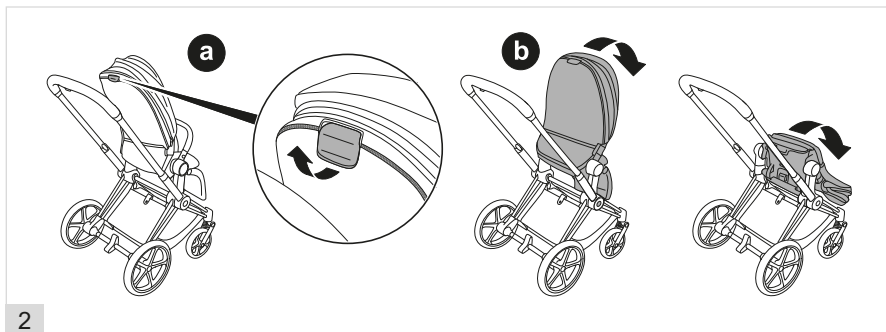
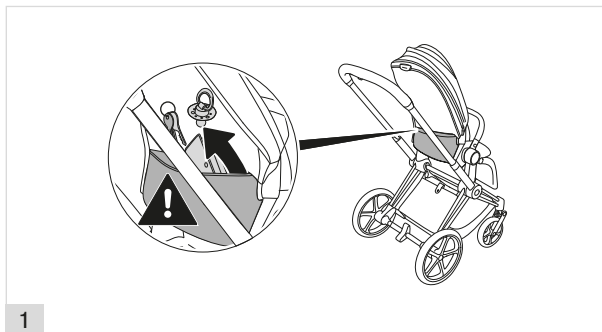

1

2

3



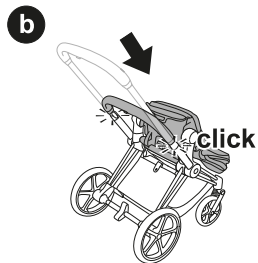
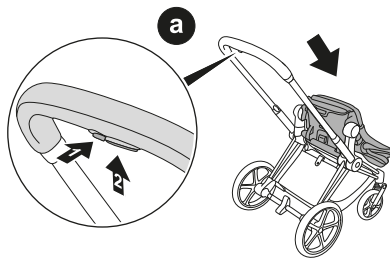

3

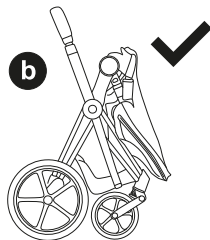
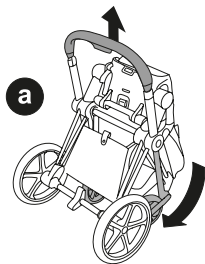

30

4

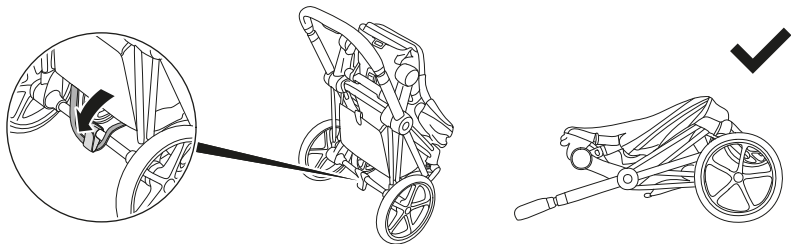

5

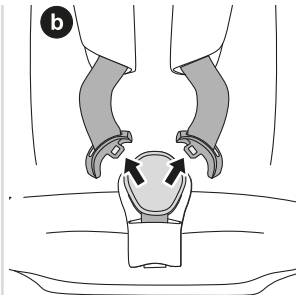
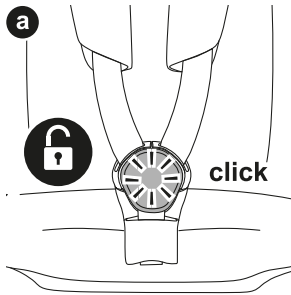

1



31

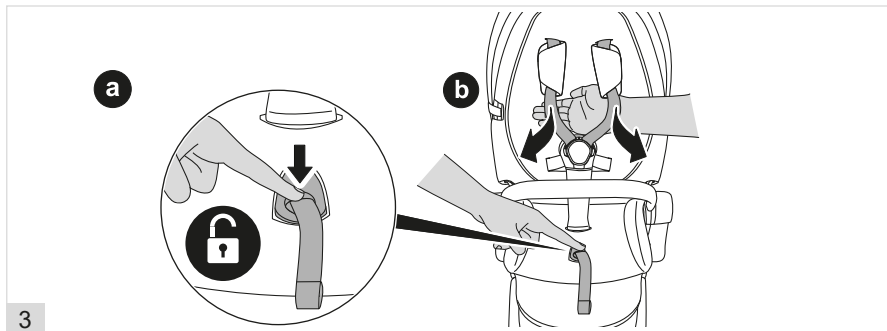
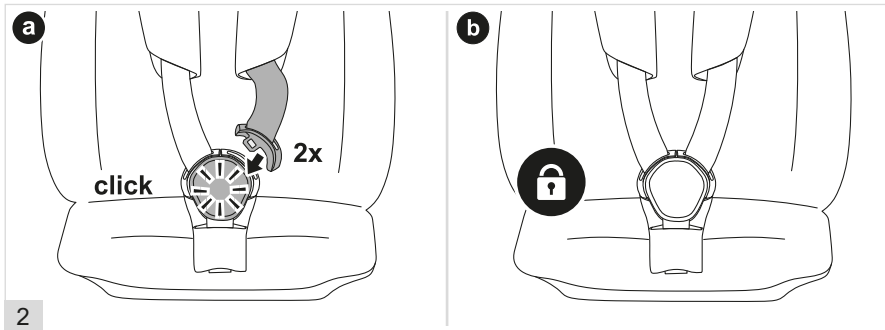



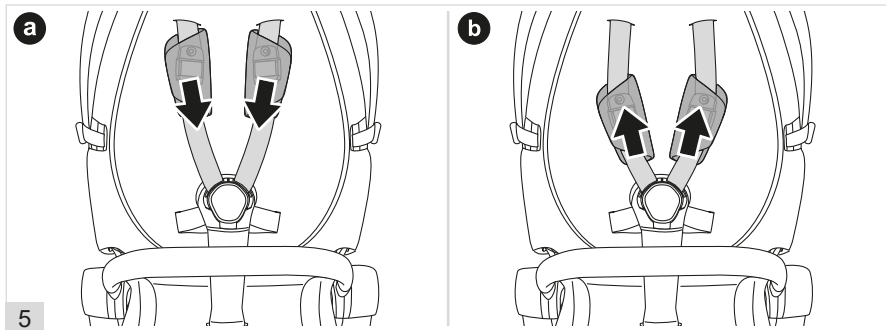
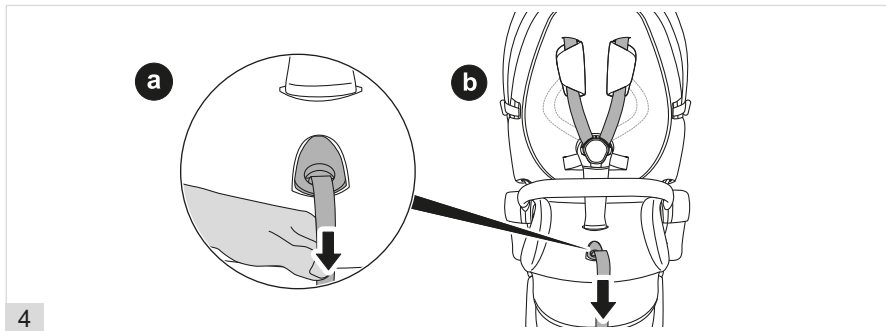

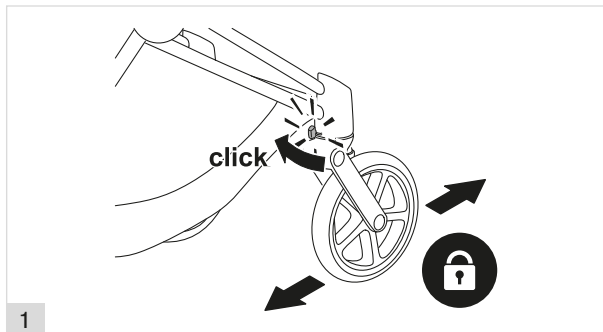
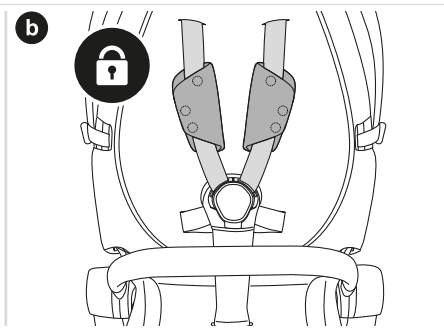
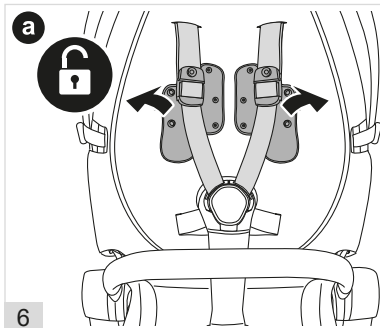

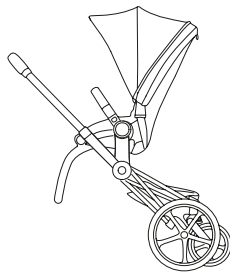
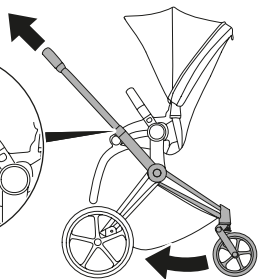
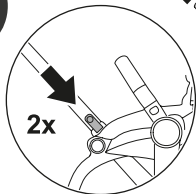

2

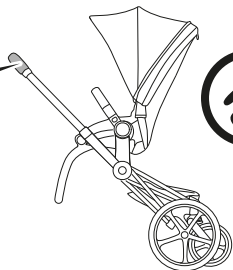
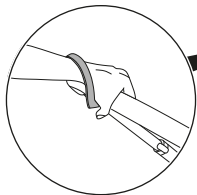

3

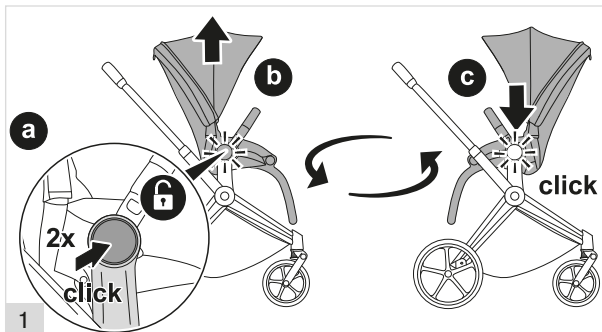
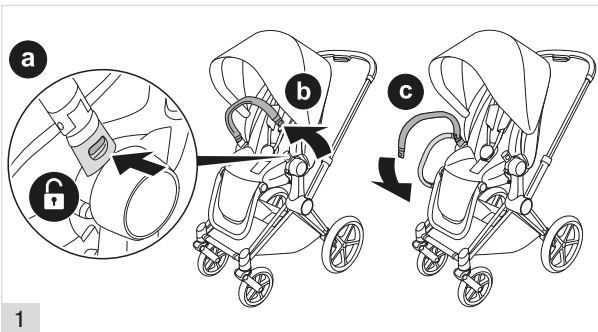

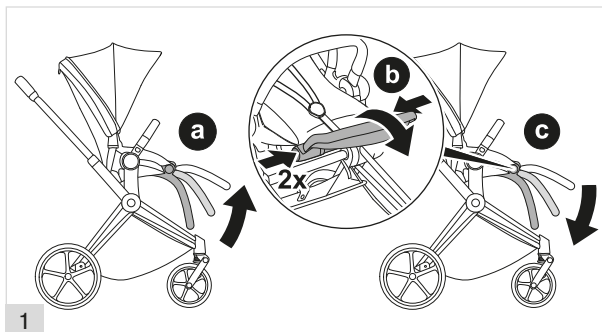
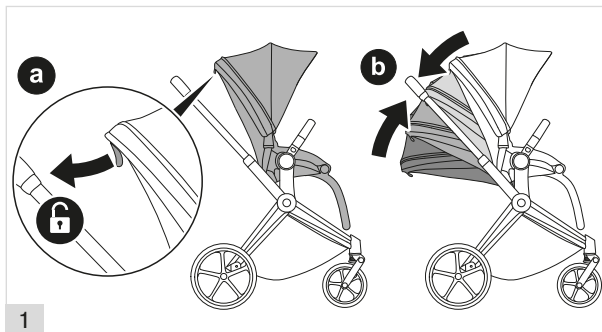



1

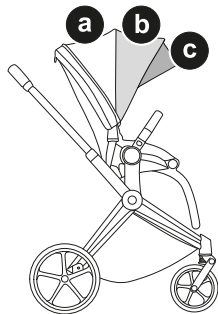
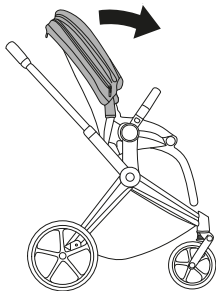

2

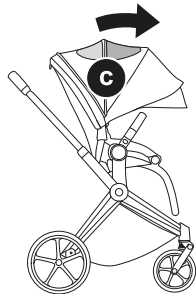
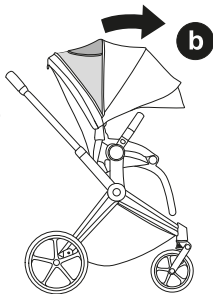
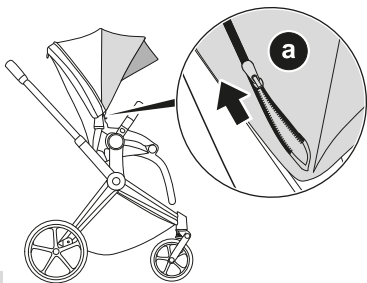

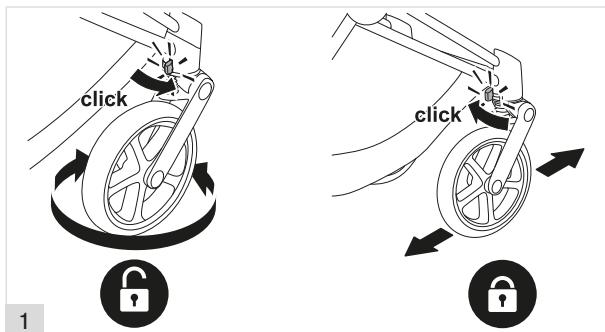
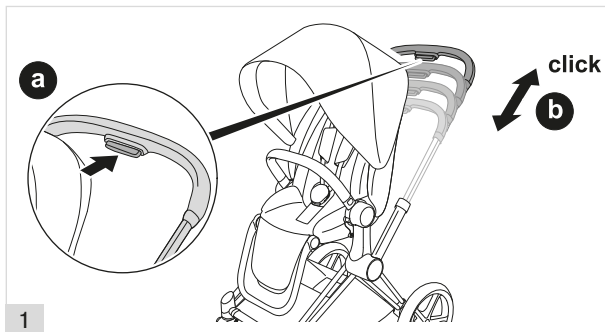

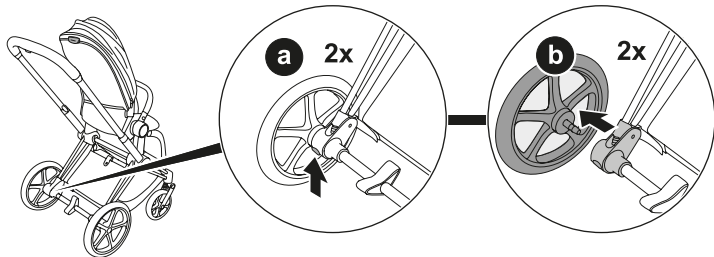
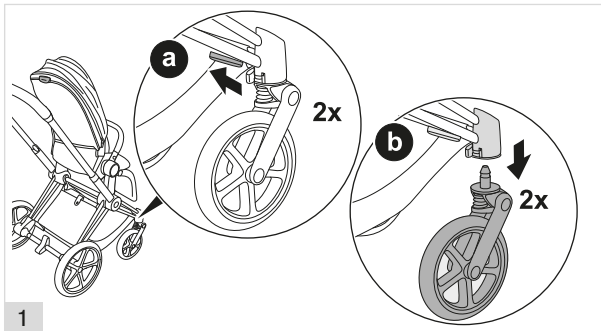



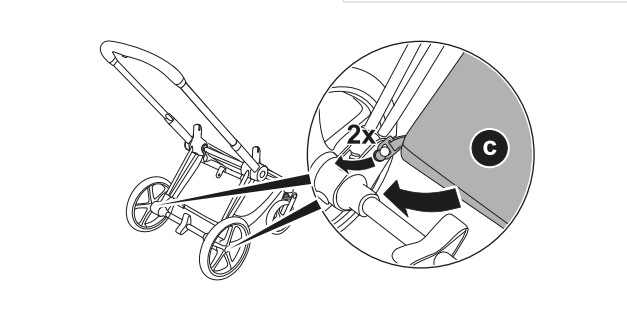
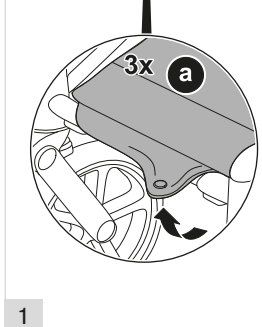
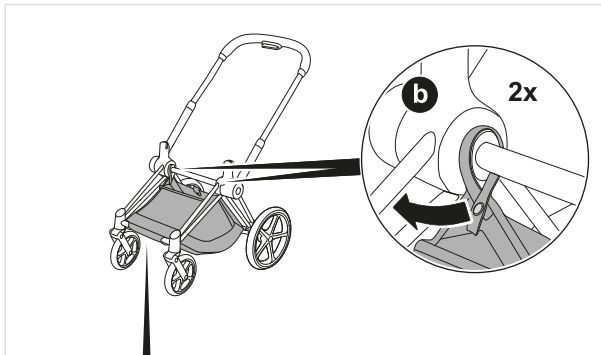

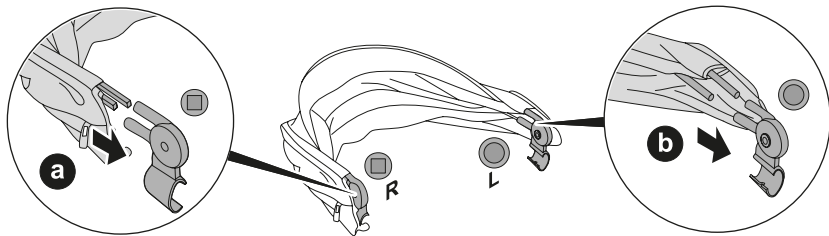

2

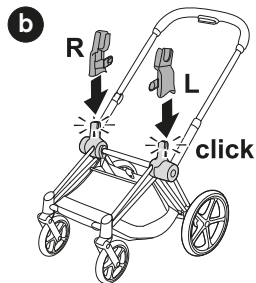
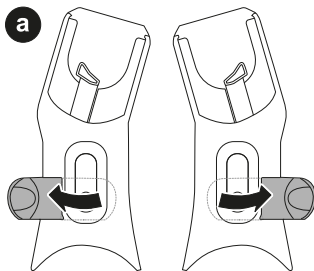

1



**C**

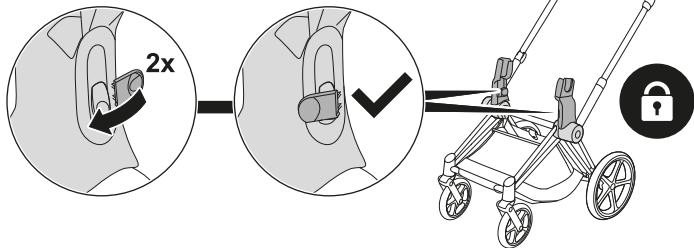

**2**

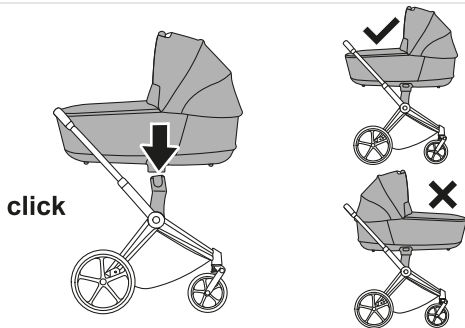

**3**

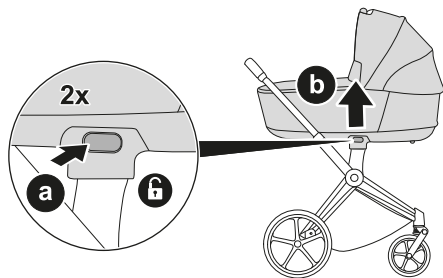

4

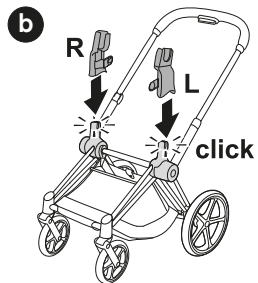
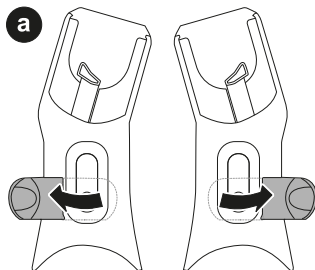

1



**C**

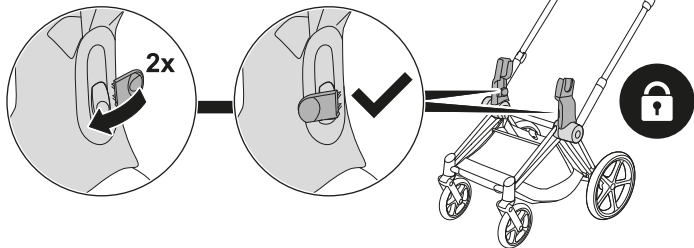

**2**

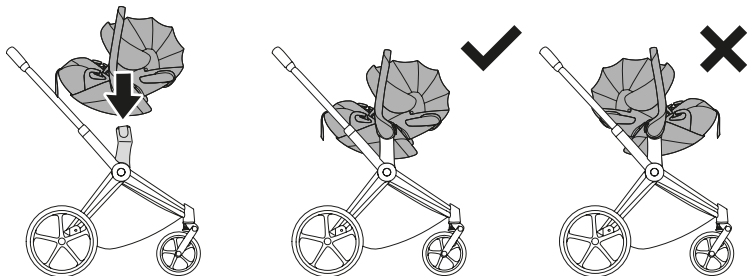

**3**

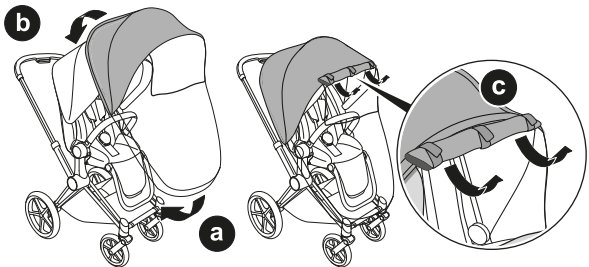

1





CYBEX GmbH

Riedingerstr. 18 | 95448 Bayreuth | Germany  
+49 (0) 921-78 511-0 | [info@cybex-online.com](mailto:info@cybex-online.com)

[www.cybex-online.com](http://www.cybex-online.com)

