

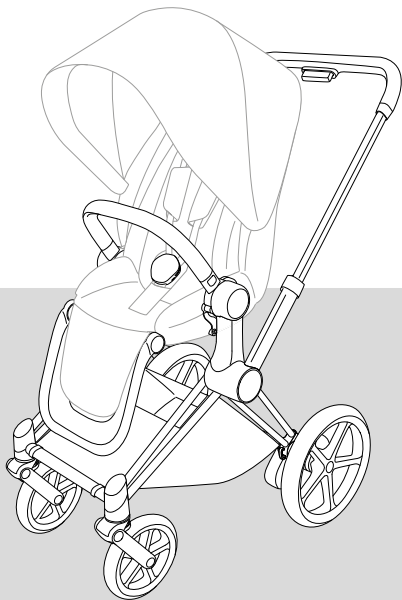

e·PRIAM
FRAME & SEAT
CHASSIS & SIÈGE





- EN** WARNING
- DE** WARNUNG
- ES** ADVERTENCIA
- FR** AVERTISSEMENT
- PT** AVISOS



- EN** Tutorial video
- DE** Videoanleitung
- ES** Tutorial en vídeo
- FR** Vidéo de démonstration
- PT** Video tutorial





- EN** Maximum weights
- DE** Maximalgewichte
- ES** Pesos máximos
- FR** Poids maximum
- PT** Pesos máximos

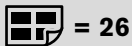

- EN** Battery
- DE** Batterie
- ES** Batería
- FR** Pile
- PT** Bateria



- EN** Product registration
- DE** Produktregistrierung
- ES** Registro del producto
- FR** Enregistrement du produit
- PT** Registo do produto

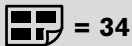

- EN** Turning on and off
- DE** Ein- und Ausschalten
- ES** Encender y apagar
- FR** Allumer et éteindre
- PT** Ligar e desligar

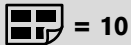

- EN** Set up
- DE** Aufbau
- ES** Instalación
- FR** Montage
- PT** Preparação

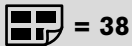

- EN** App
- DE** App
- ES** Aplicación
- FR** Appli
- PT** Aplicação



 = 40

- EN** Rocking feature
- DE** Schaukelfunktion
- ES** Función de balanceo
- FR** Fonction basculante
- PT** Funcionalidade de embalo



 = 43

- EN** Uneven surface assist
- DE** Smarte Unterstützung bei unebenen Oberflächen
- ES** Asistencia para superficies irregulares
- FR** Assistance sur les surfaces inégales
- PT** Assistência às superfícies irregulares



 = 41

- EN** Hands positioning
- DE** Positionierung der Hände
- ES** Posicionamiento de las manos
- FR** Positionnement des mains
- PT** Posicionamento das mãos



 = 44

- EN** Folding
- DE** Faltung
- ES** Plegado
- FR** Pliant
- PT** Fecho



 = 42

- EN** Smart hill assist
- DE** Smarte Unterstützung bei hügeligem Gelände
- ES** Asistencia inteligente para cuestas
- FR** Assistance intelligente dans les pentes
- PT** Assistência aos declives inteligente



 = 46

- EN** Two wheel mode
- DE** Zweirad-Modus
- ES** Modo de dos ruedas
- FR** Mode deux roues
- PT** Modo de duas rodas



 = 47

- EN** Brake
- DE** Bremse
- ES** Freno
- FR** Frein
- PT** Bloqueio



 = 49

- EN** Backrest
- DE** Rückenlehne
- ES** Respaldo
- FR** Dossier
- PT** Encosto de costas



 = 48

- EN** Handle bar
- DE** Schiebegriff
- ES** Manillar
- FR** Poignée de poussée
- PT** Guiador



 = 49

- EN** Legrest
- DE** Beinstütze
- ES** Reposapiés
- FR** Repose-pieds
- PT** Apoio de pernas



 = 48

- EN** Seat direction
- DE** Sitzrichtung
- ES** Dirección de la silla
- FR** Sens du siège
- PT** Orientação do assento



 = 50

- EN** Bumper bar
- DE** Schutzbügel
- ES** Barra de seguridad
- FR** Barre de protection
- PT** Barra de segurança



 = 50

- EN** Harness
- DE** Gurtsystem
- ES** Arnés
- FR** Harnais
- PT** Arnês



 = 55

- EN** Removing the wheels
- DE** Entfernen der Räder
- ES** Quitar las ruedas
- FR** Retrait des roues
- PT** Remover as rodas



 = 53

- EN** Sun canopy
- DE** Sonnenverdeck
- ES** Capota para el sol
- FR** Pare-soleil
- PT** Capota solar



 = 56

- EN** Rain cover
- DE** Regenverdeck
- ES** Funda para la lluvia
- FR** Housse de pluie
- PT** Capa de chuva



 = 54

- EN** Swivel locks
- DE** Schwenkradsperre
- ES** Bloqueos de dirección
- FR** Verrous pivotants
- PT** Bloqueios de rotação



 = 56

- EN** Infant Car Seat
- DE** Babyschale
- ES** Silla infantil para coche
- FR** Siège auto pour enfant
- PT** Cadeira auto infantil

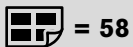

- EN** Carry Cot
- DE** Kinderwagenaufsatz
- ES** Capazo
- FR** Navelle bébé
- PT** Alcofa

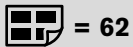

- EN** Removing the fabric
- DE** Entfernen des Bezuges
- ES** Quitar la tela
- FR** Retrait du tissu
- PT** Remover o tecido

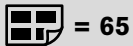

- EN** Troubleshooting
- DE** Fehlerbehebung
- ES** Resolución de problemas
- FR** Dépannage
- PT** Resolução de problemas

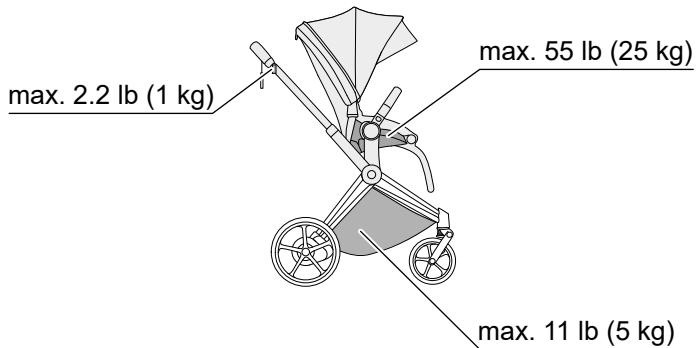

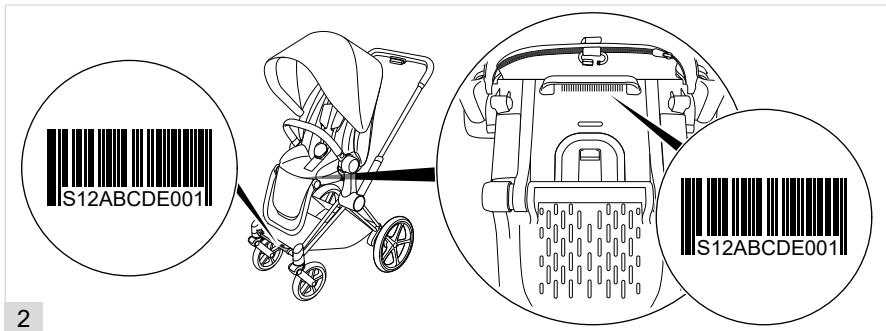
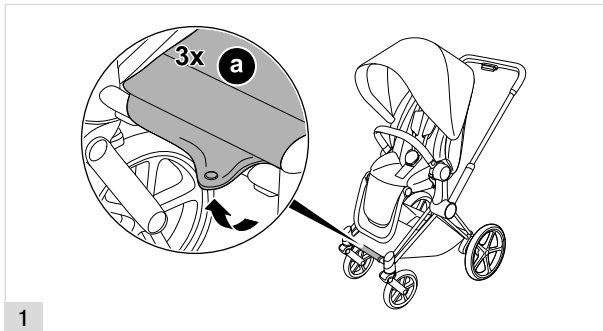

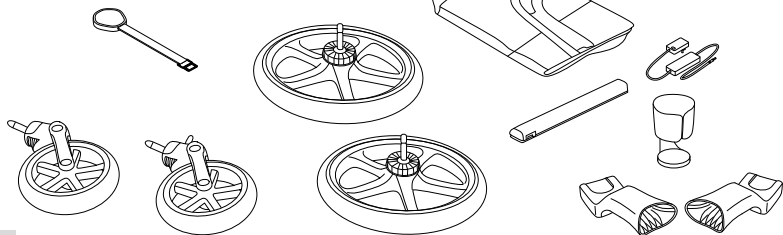
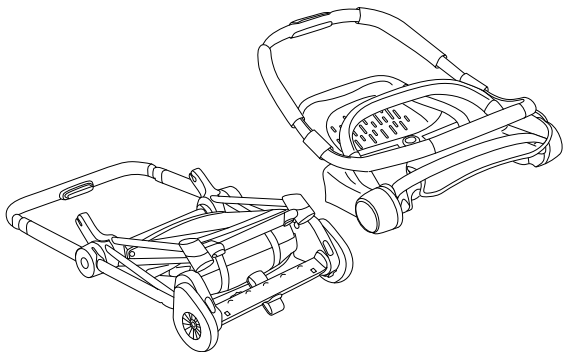

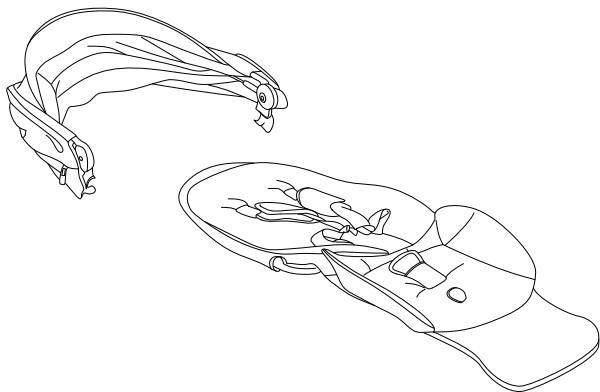

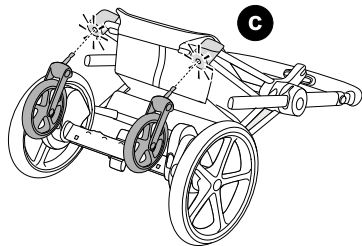
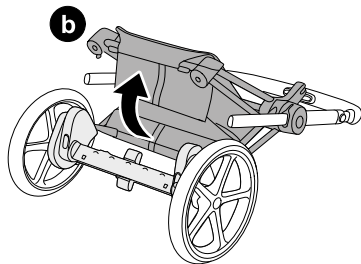
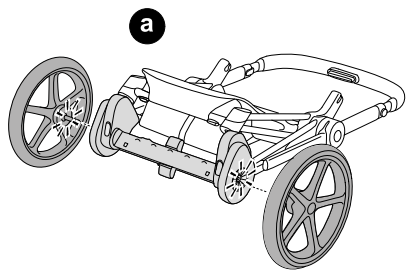

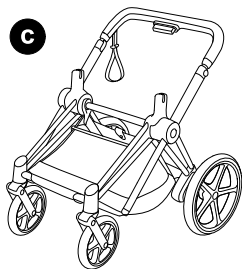
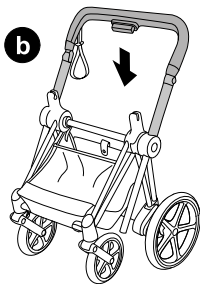
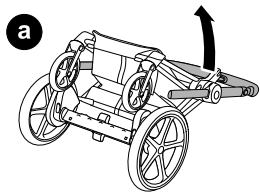

4

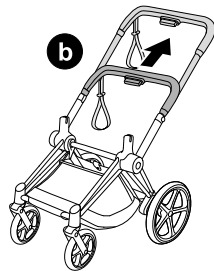
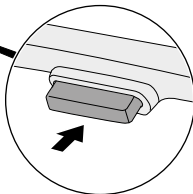
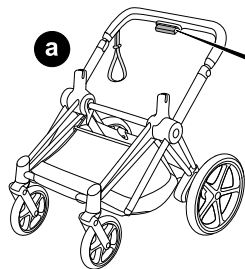

5

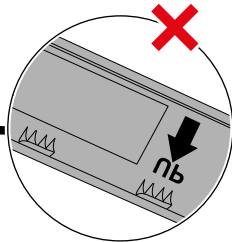
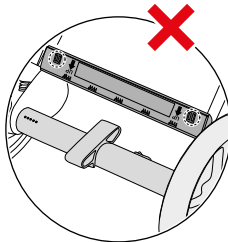
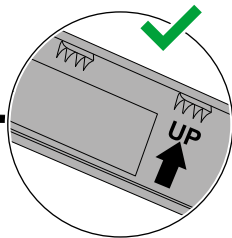
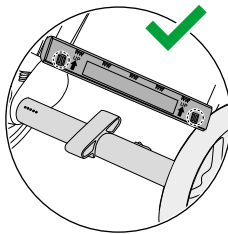
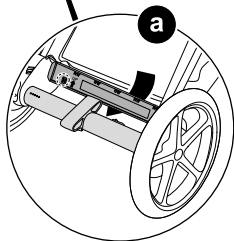
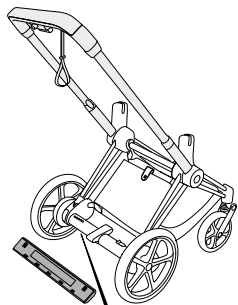

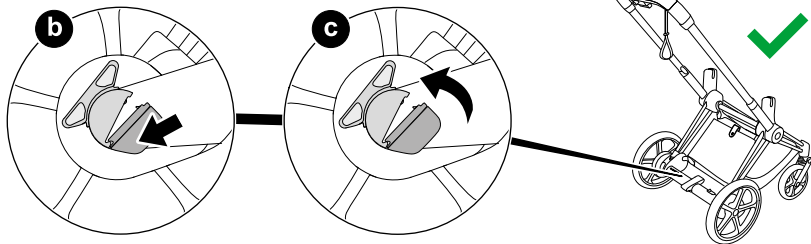

7

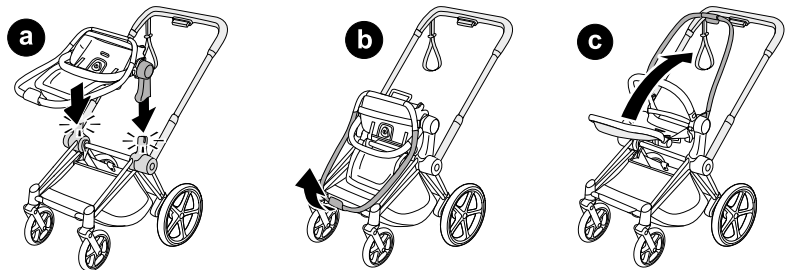

8

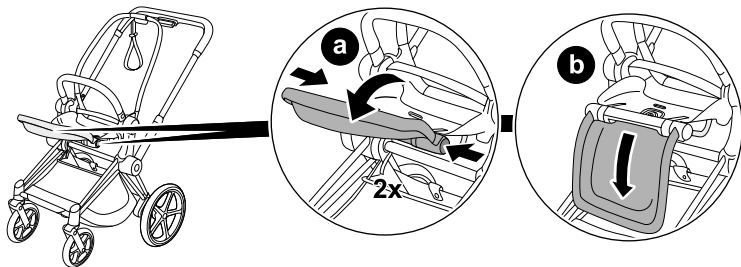

9



16

10

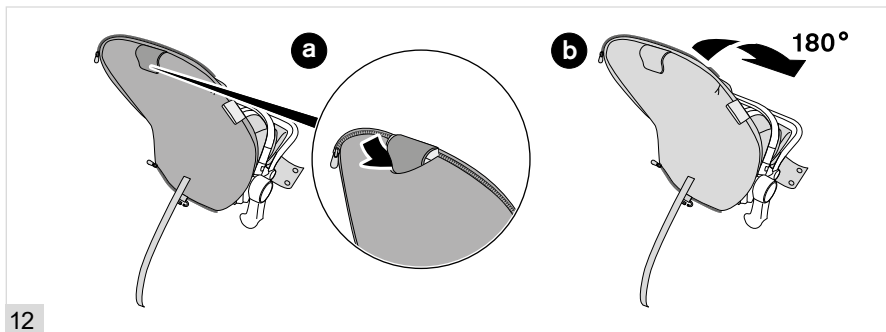
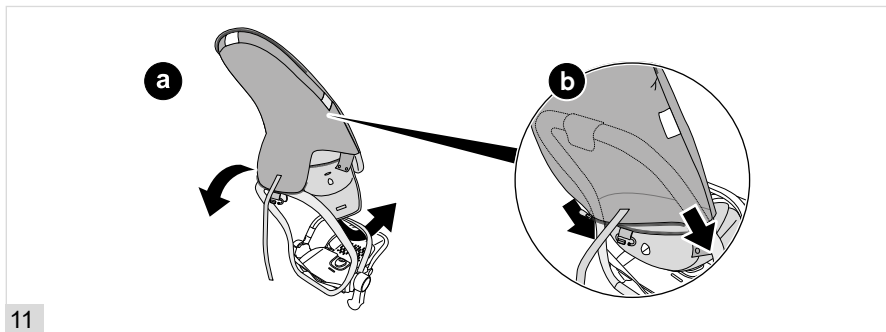

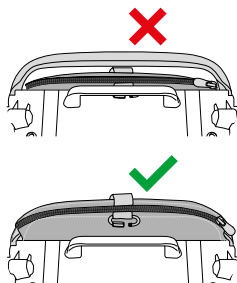
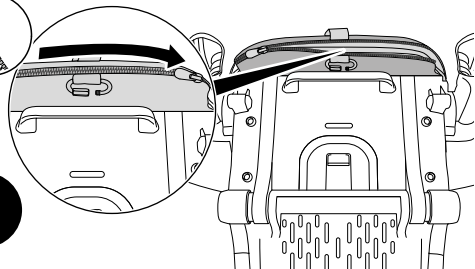

13

a

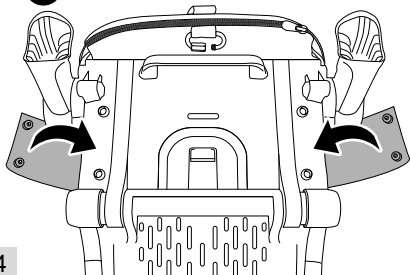

b

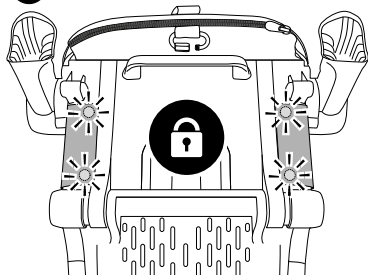

18

14



15

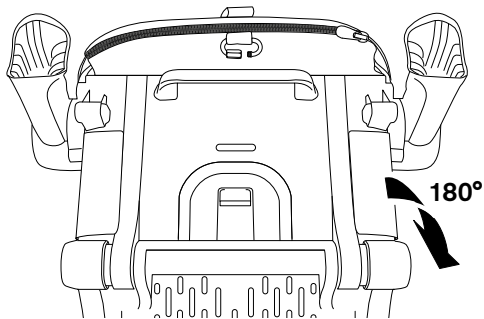

16

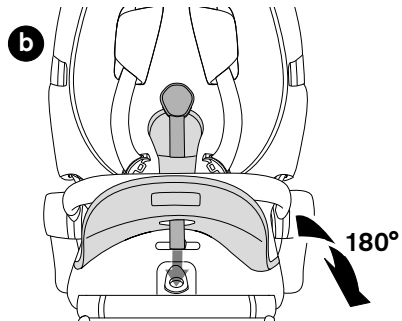
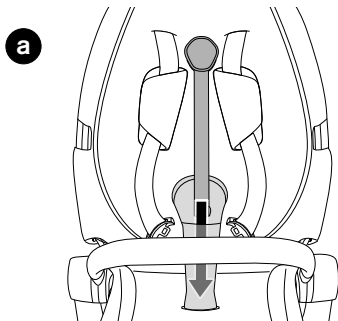

19

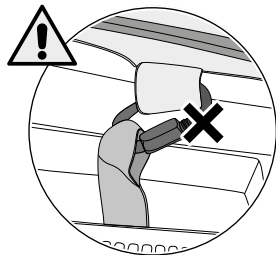
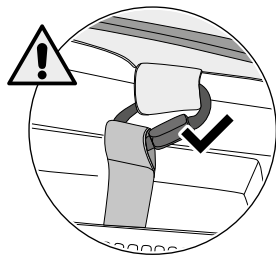
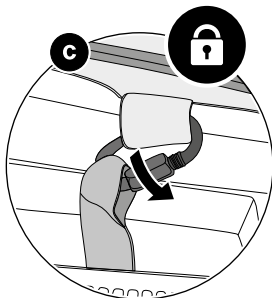
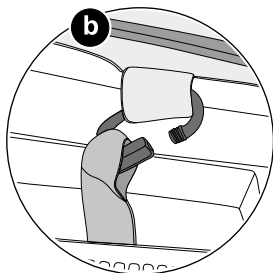
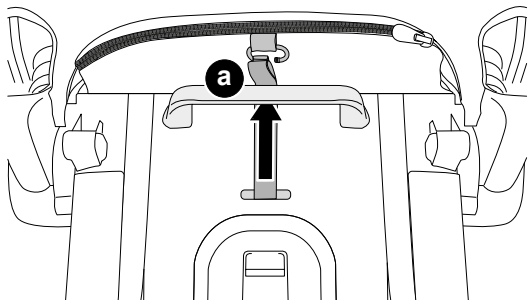



18

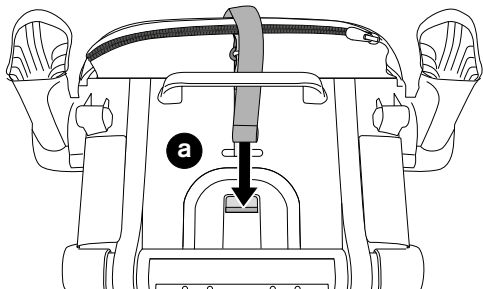

19

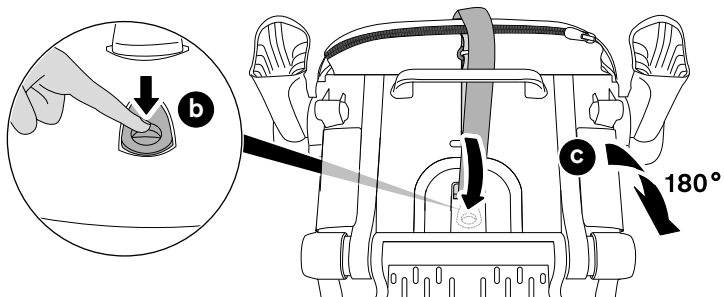

21

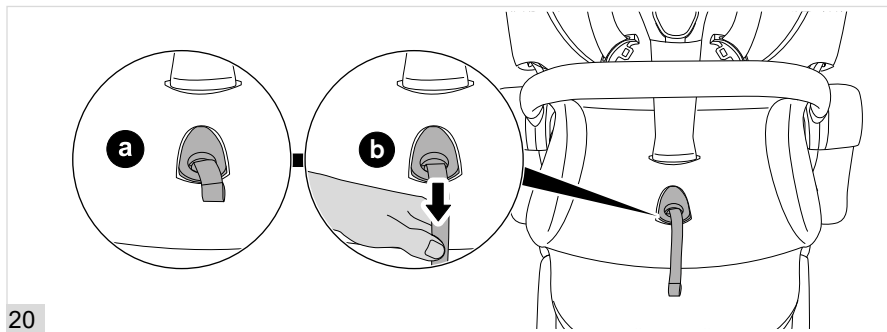

20

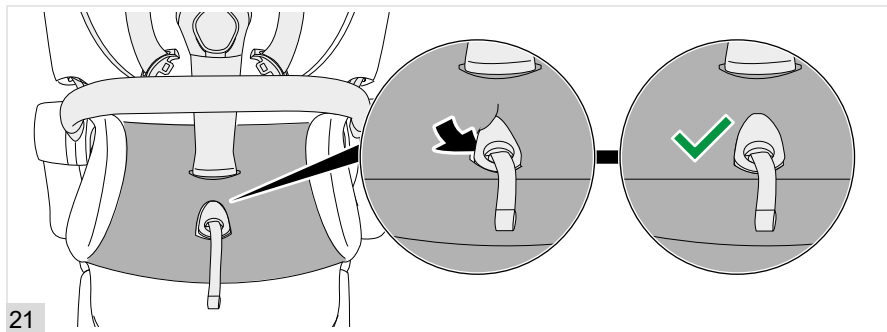

22

21

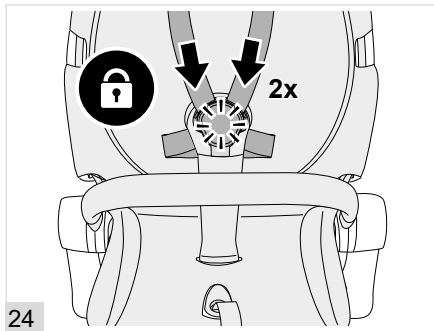
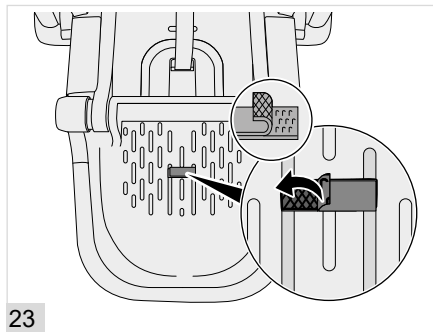
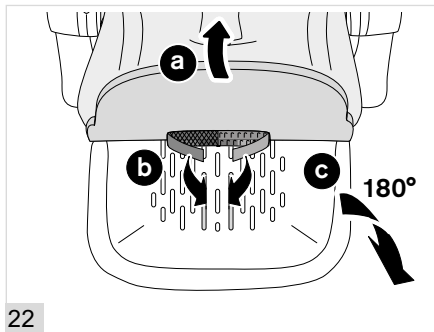

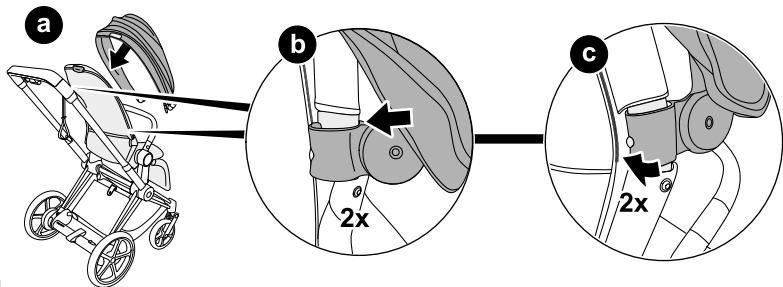

26

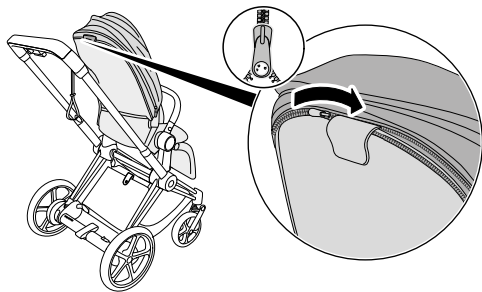

27

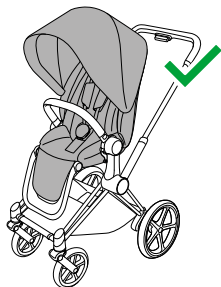
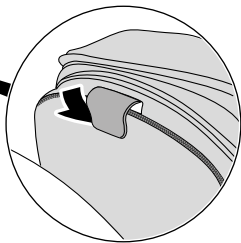

28

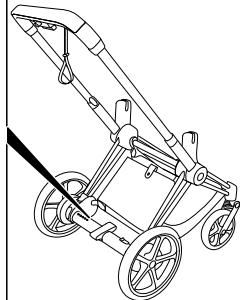
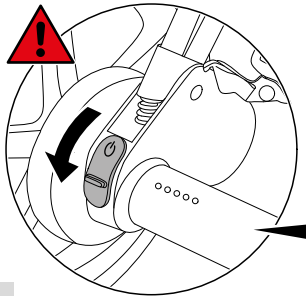

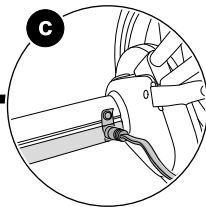
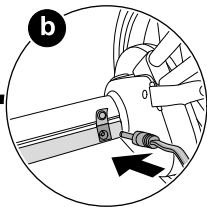
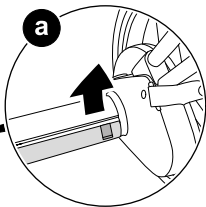
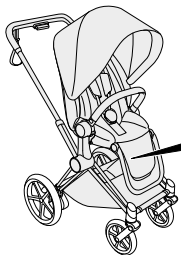

2

100 - 240 V
50/60Hz 1,3A

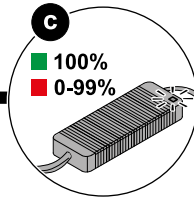
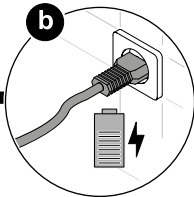
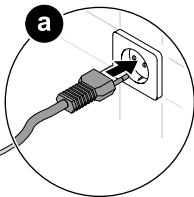

3

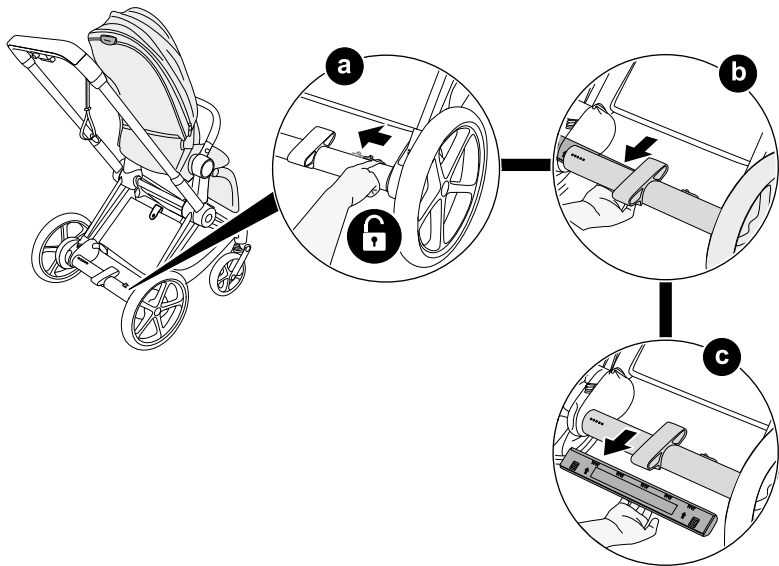

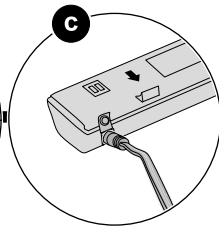
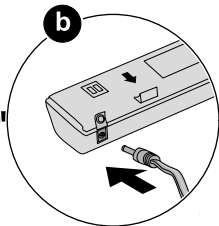
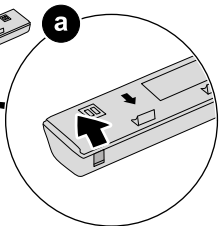
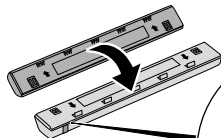

5

100 - 240 V
50/60Hz 1,3A

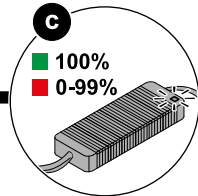
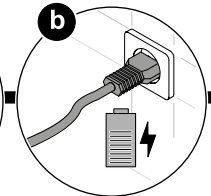
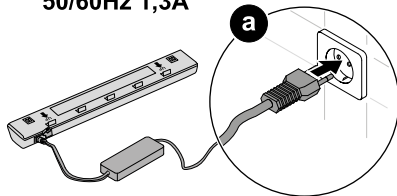

6

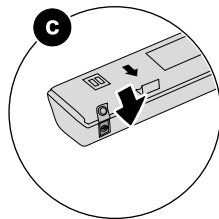
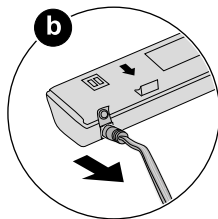
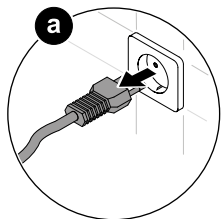

7

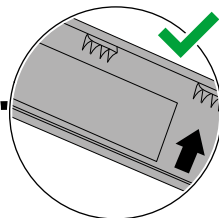
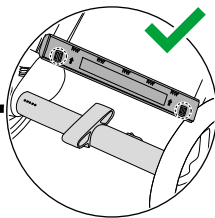
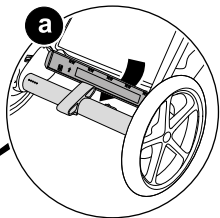
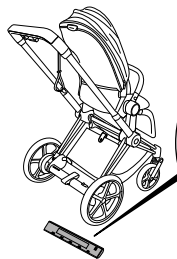

30

8

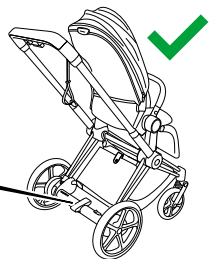
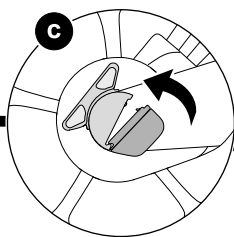
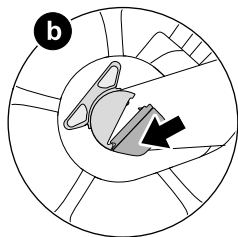

9

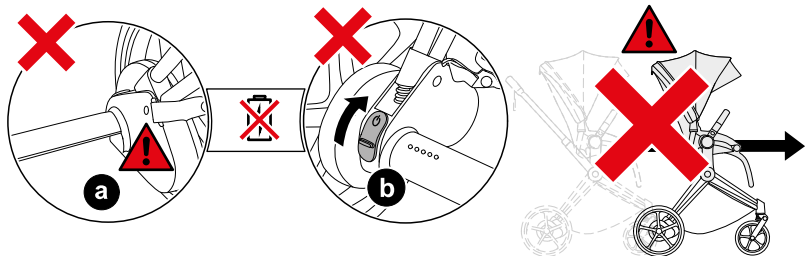
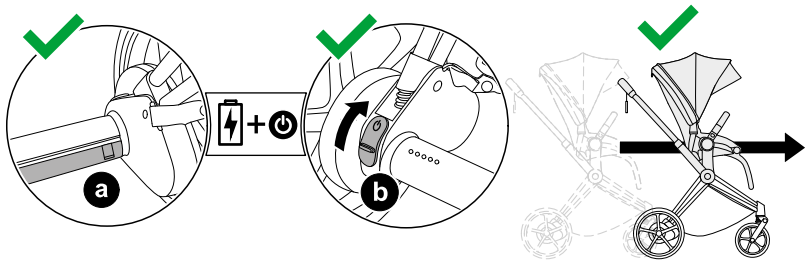

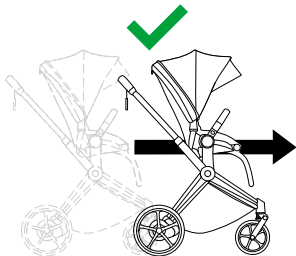
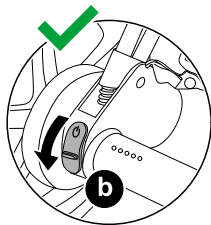
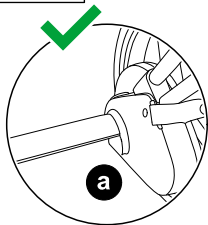

11

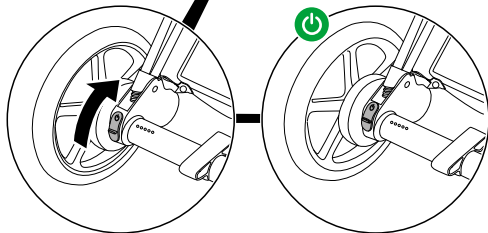
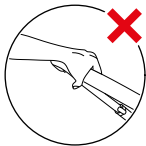
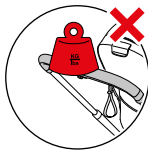
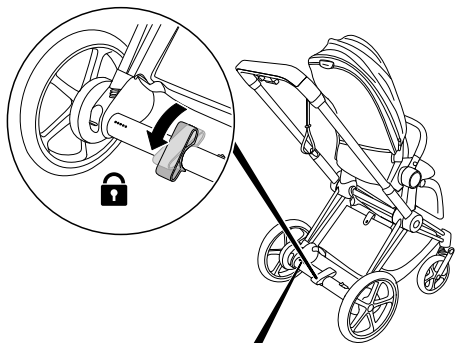

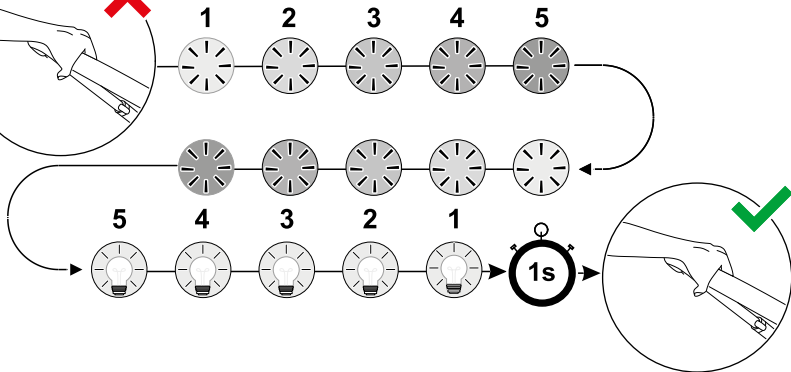
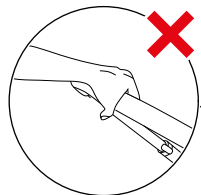
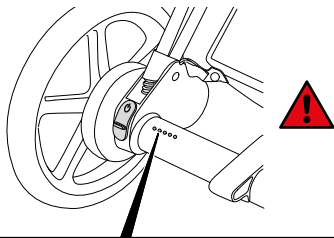
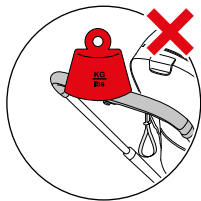

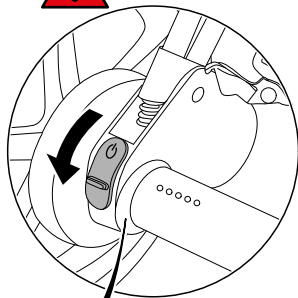
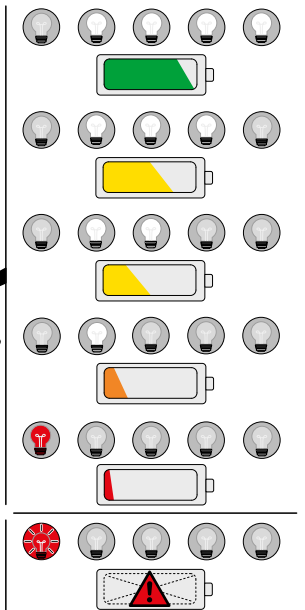
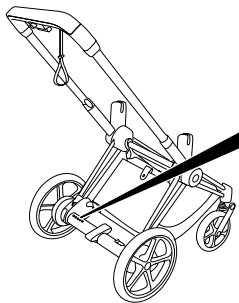

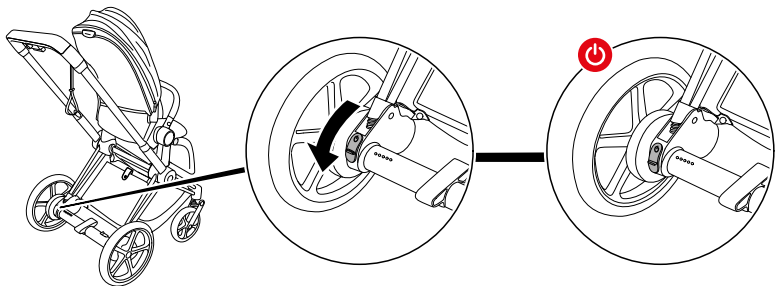

4



1

a



b

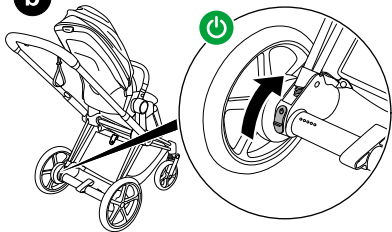

2

c

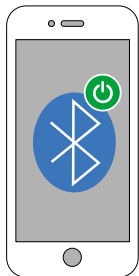

3



d

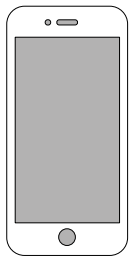

max. 1 m ↔



4

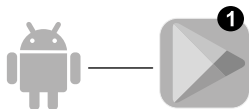

5

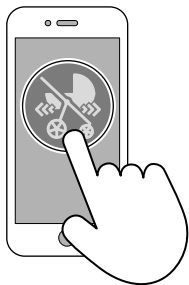

1

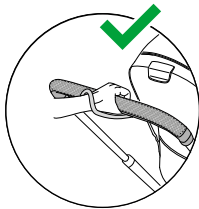
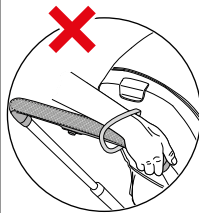
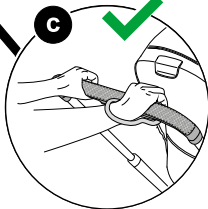
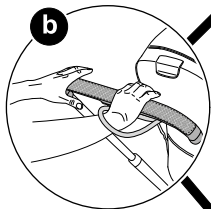
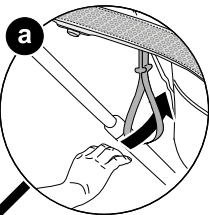
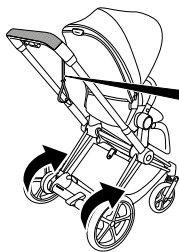



1

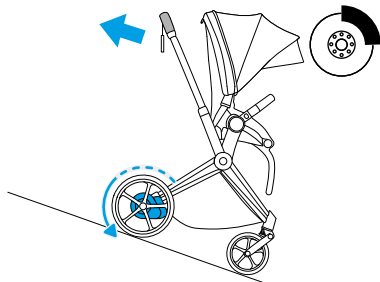
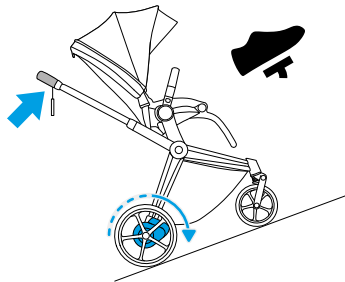

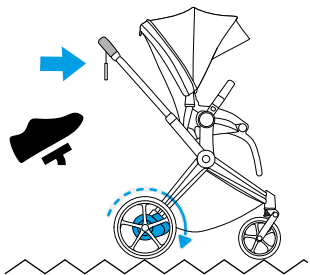

1





a

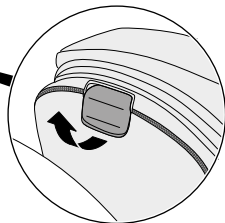
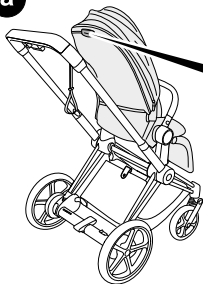

b

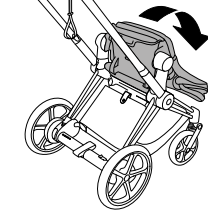
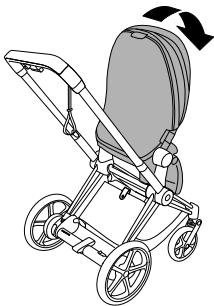

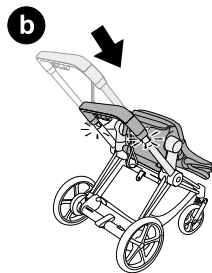
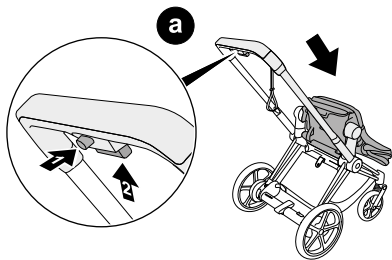

2

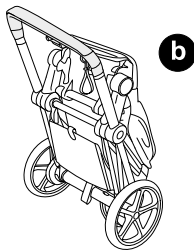
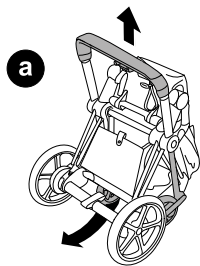

3



1

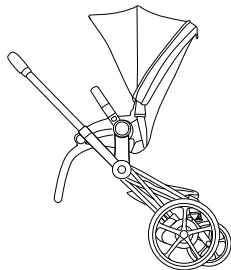
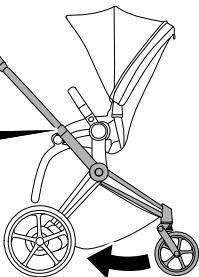
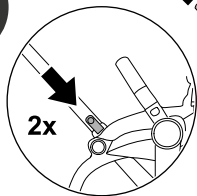
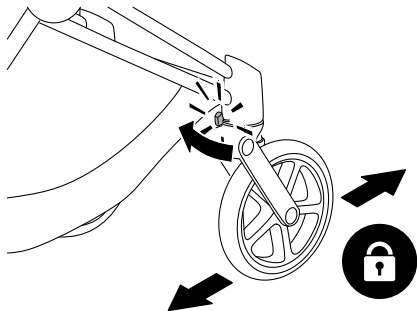

2

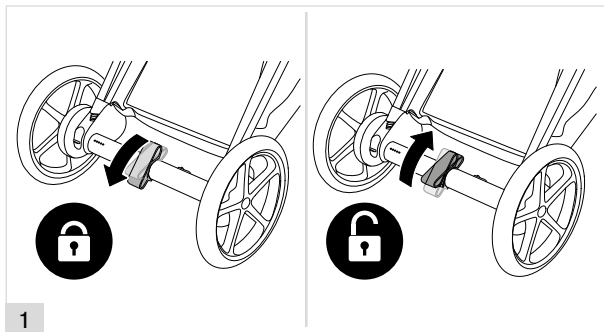
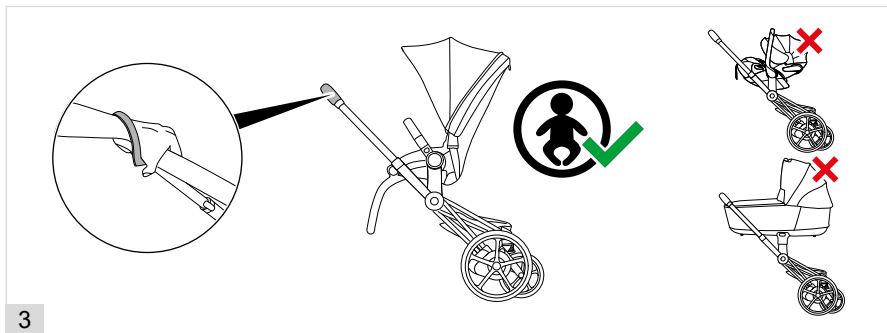



a

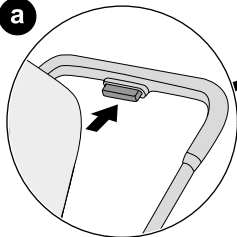

b

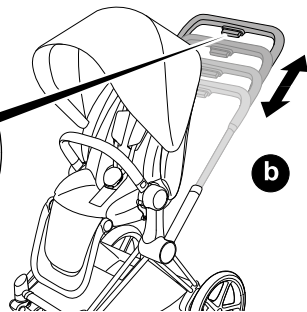

1



a

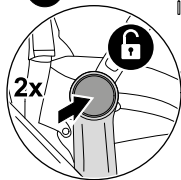

b

c

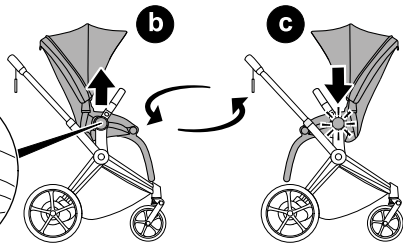

1

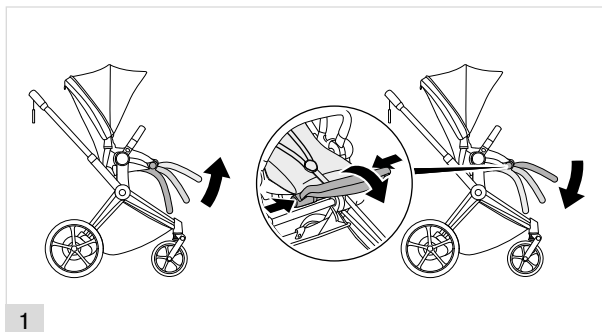
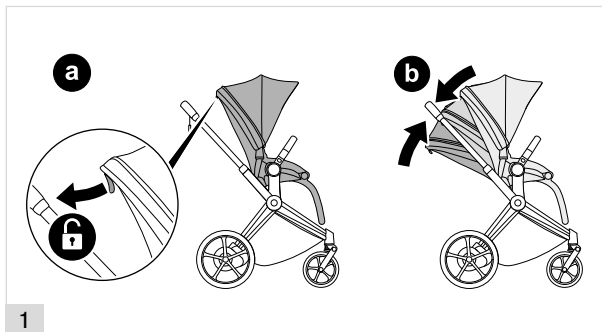

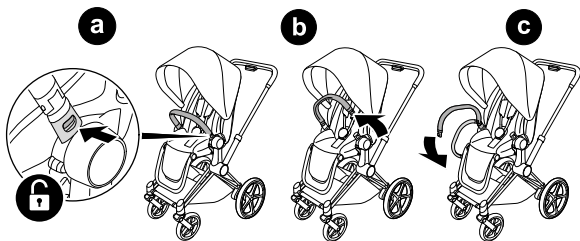

1

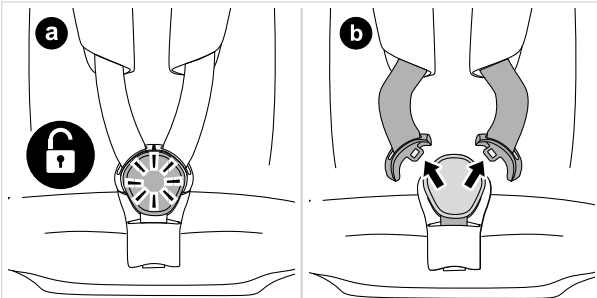

1

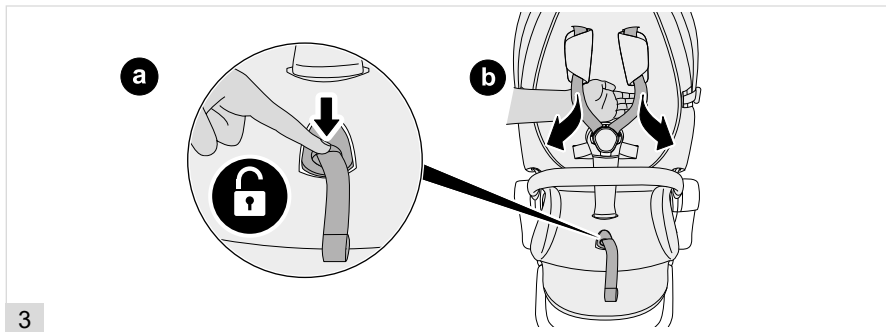
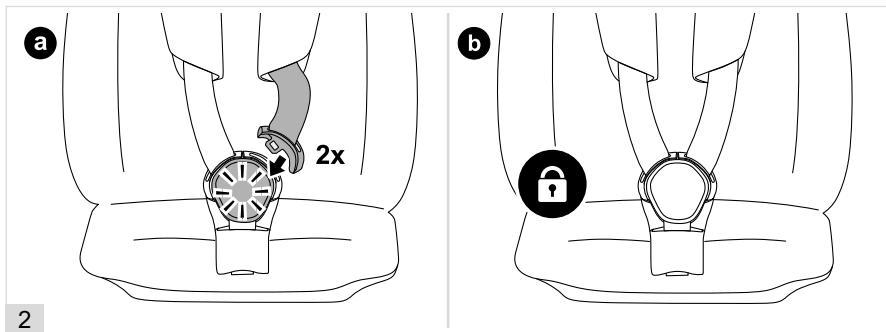

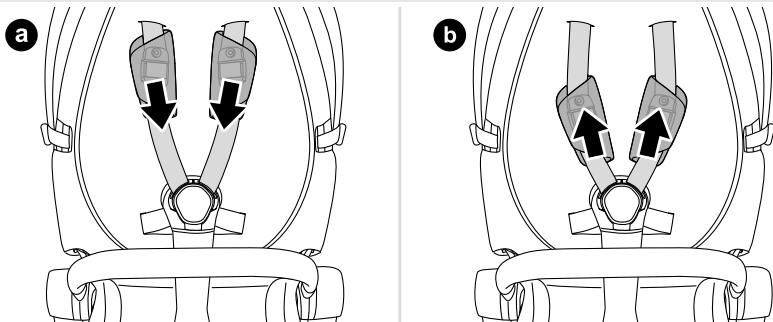
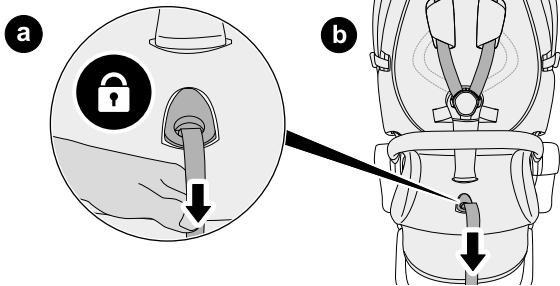

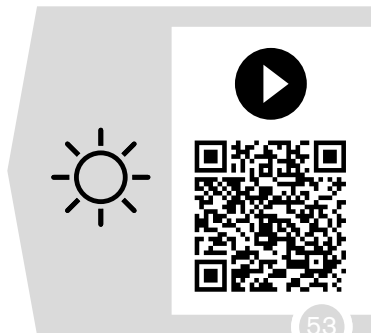
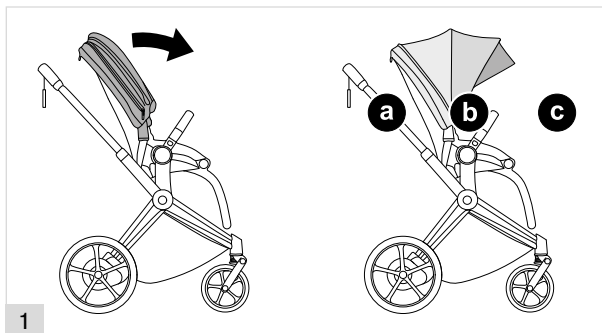
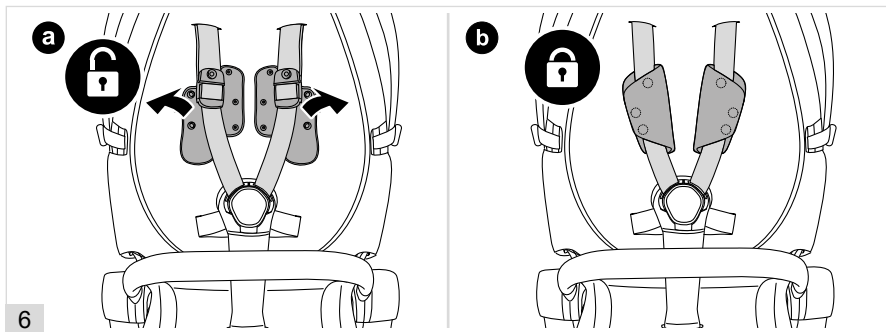

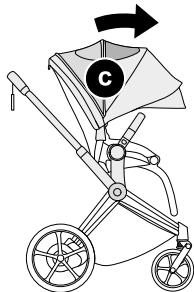
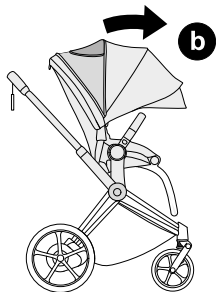
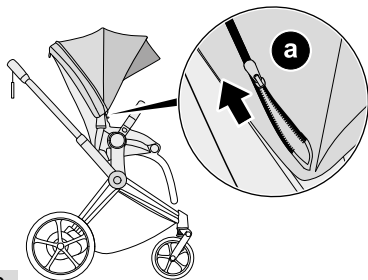

2

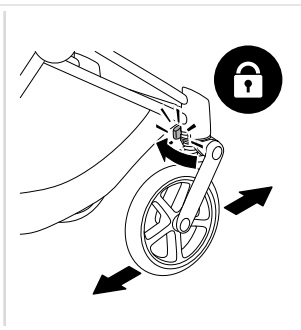
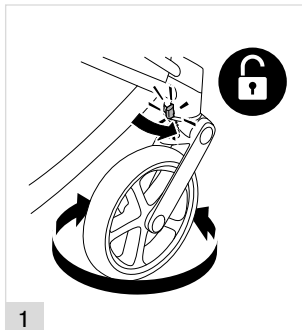

1

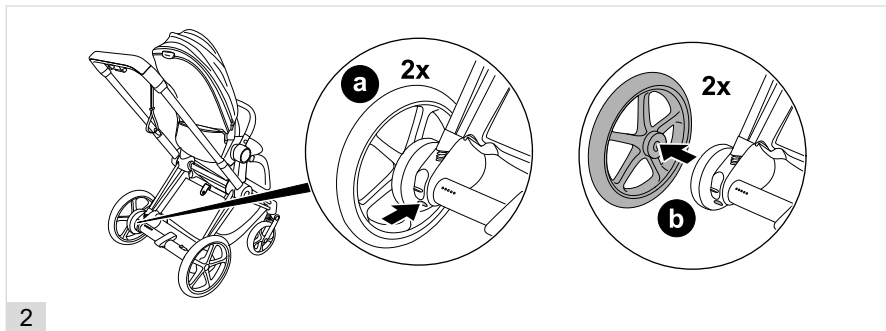
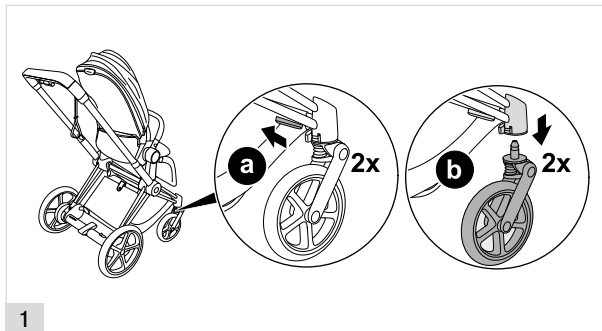

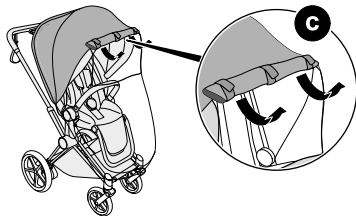

1

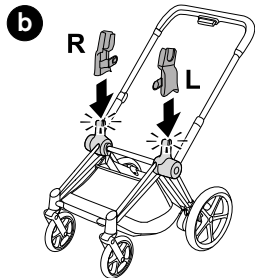
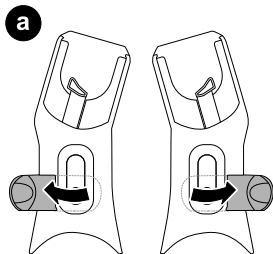

1

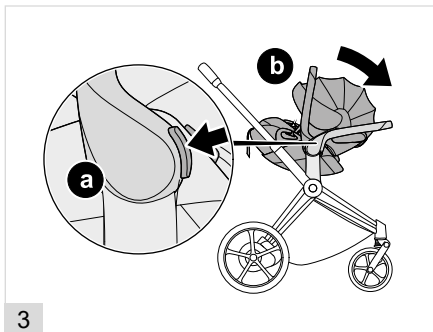

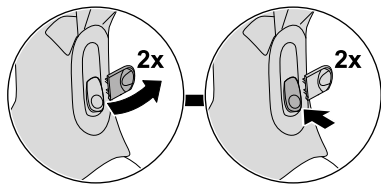

a

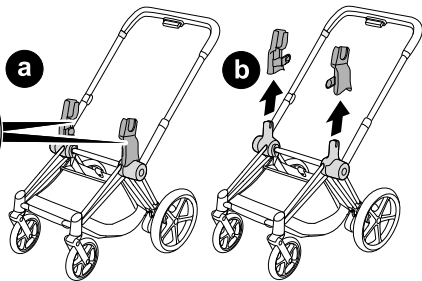

b

5



58

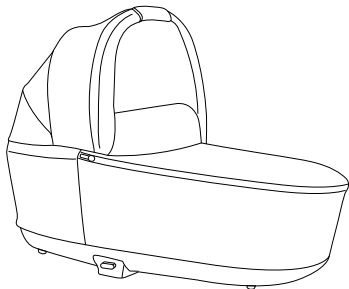

1

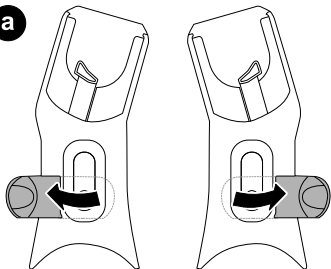
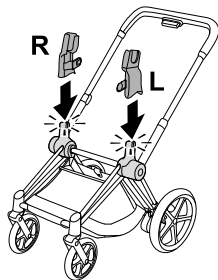
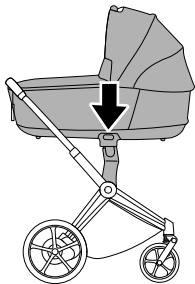
**a****2****b****3****4**

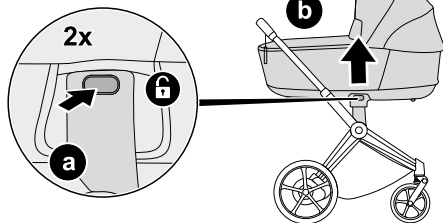

5

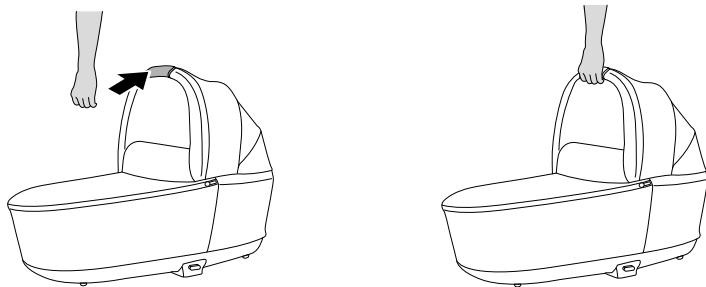

6

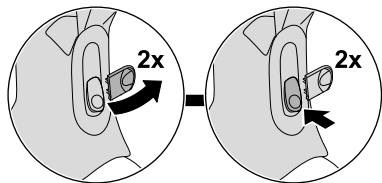

a

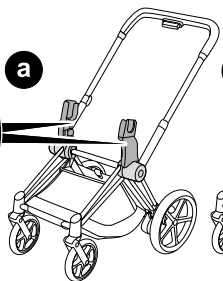

b

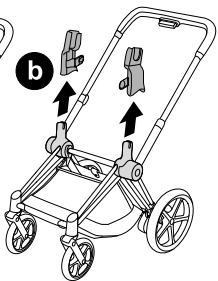

7

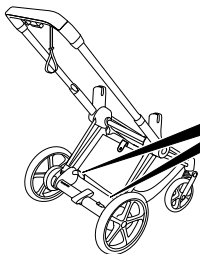
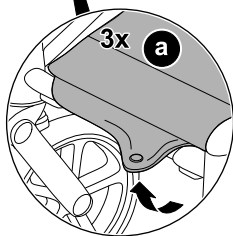
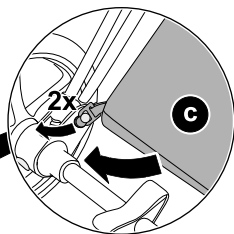
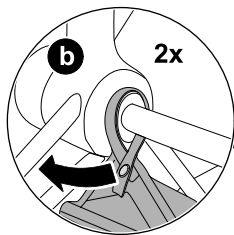

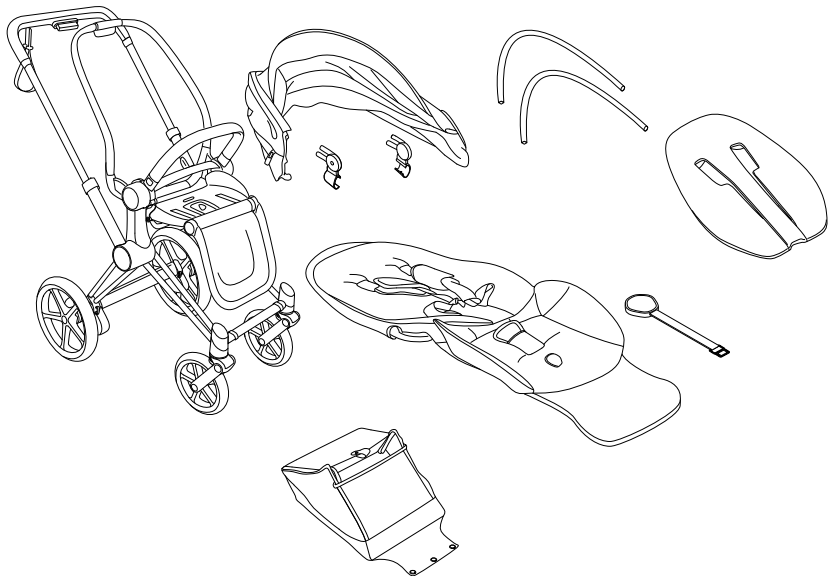

Troubleshooting



EN / DE / FR / ES

66

PT

70





**Indicator lights / Kontrolllampen /
Voyants d'indication / Luces indicadoras**

**Description / Beschreibung / Description /
Descripción**



Only the red light flashes.

Nur die rote Lampe blinkt.

Seul le voyant rouge clignote.

Solo parpadea la luz roja.



Red light is flashing and the LED spot next to the red light shines white permantly.

Die rote Lampe blinkt und der LED Spot neben der roten Lampe leuchtet permanent in weiß.

Le voyant rouge clignote et le spot LED à côté du voyant rouge émet une lumière blanche continue.

La luz roja parpadea y el foco LED junto a la luz roja está encendido en blanco de forma permanente.



Meaning / Bedeutung / Signification / Significado	Actions / Maßnahmen / Actions / Acciones
<p>The battery is empty. The stroller will decelerate permanently.</p> <p>Die Batterie ist leer. Der Kinderwagen wird permanent abgebremst.</p> <p>La batterie est vide. La poussette va freiner en permanence.</p> <p>La batería está vacía. El carrito frenará permanentemente.</p>	<p>Please turn off the ePriam & charge the battery!</p> <p>Bitte schalten Sie den ePriam aus und laden die Batterie auf!</p> <p>Veillez éteindre l'ePriam et charger la batterie !</p> <p>Apague ePriam y cargue la batería.</p>
<p>No signal from the handle bar. Support is not working anymore.</p> <p>Kein Signal von dem Schiebegriff. Unterstützung nicht mehr vorhanden.</p> <p>Pas de signal du guidon. L'assistance ne fonctionne plus.</p> <p>No hay señal procedente del manillar. El soporte no funciona.</p>	<p>Please fold & unfold the stroller. If the LED status remains the same please get in touch with your retailer!</p> <p>Bitte den Kinderwagen Zusammen- und Auffalten. Bleibt der LED Status der gleiche setzen Sie sich bitte mit Ihrem Händler in Verbindung.</p> <p>Veillez plier et déplier la poussette. Si l'état du voyant LED reste le même, veuillez contacter votre revendeur.</p> <p>Pliegue y despliegue el carrito. Si el LED de estado permanece igual, póngase en contacto con su distribuidor.</p>



**Indicator lights / Kontrolllampen /
Voyants d'indication / Luces indicadoras**

**Description / Beschreibung / Description /
Descripción**



Red light is flashing and all 4 white LED spots are shining permanently.

Die rote Lampe blinkt und alle 4 LED Spots leuchten permanent.

Le voyant rouge clignote et les 4 spots LED blancs sont allumés en permanence.

La luz roja parpadea y los 4 focos LED están encendidos permanentemente.



Meaning / Bedeutung / Signification / Significado	Actions / Maßnahmen / Actions / Acciones
<p>Error in calibration of the handle bar sensors. Support is not working anymore.</p> <p>Kalibrierungsfehler der Sensoren im Schiebegriff. Unterstützung nicht mehr vorhanden.</p> <p>Erreur de calibrage des capteurs du guidon. L'assistance électrique ne fonctionne plus.</p> <p>Error de calibración de los sensores del manillar. El soporte no funciona.</p>	<p>Please activate the foot brake and turn off the ePriam. Remove the weight on the handle bar and do not hold the handle bar. Now turn on the ePriam again. If the LED status remains the same please get in touch with your retailer.</p> <p>Bitte betätigen Sie die Feststellbremse und schalten den ePriam aus. Entfernen Sie das Gewicht vom Schiebegriff und halten Sie nicht den Schiebegriff fest. Schalten Sie nun den ePriam wieder an. Bleibt der LED Status der gleiche setzen Sie sich bitte mit Ihrem Händler in Verbindung.</p> <p>Veillez activer la pédale de frein et éteindre l'ePriam. Retirez la pression sur le guidon et ne le tenez pas. Allumez à nouveau l'ePriam. Si l'état du voyant LED reste le même, veuillez contacter votre revendeur.</p> <p>Por favor pise el pedal de freno y apague el ePriam. Retire el peso del manillar y no mantenga sujeto el manillar. A continuación, encienda de nuevo el ePriam. Si el LED de estado permanece igual, por favor póngase en contacto con su distribuidor.</p>



Luzes indicadoras

Descrição



Apenas a luz vermelha pisca.



A luz vermelha pisca e o spot LED próximo da luz vermelha emite uma luminosidade branca permanente.



Significado	Ações
<p>A bateria está descarregada. O carrinho diminuirá permanentemente a velocidade.</p>	<p>Desligue o ePriam e carregue a bateria!</p>
<p>Ausência de sinal do guiador. O suporte já não funciona.</p>	<p>Rebata e abra o carrinho. Se o estado do LED permanecer sem alterações, entre em contacto com o ponto de venda!</p>



Luzes indicadoras

Descrição



A luz vermelha pisca e os 4 spots LED brilham permanentemente.



Significado	Ações
<p>Erro de calibragem dos sensores do guiador. O suporte já não funciona.</p>	<p>Ative o travão de pedal e desligue o ePriam. Retire o peso do guiador e largue-o. Ligue novamente o ePriam. Se o estado do LED permanecer sem alterações, entre em contacto com o ponto de venda.</p>



AMERICAS

Columbus Trading-Partners USA Inc.
120 Royall Street, Suite 101 | Canton, MA 02021 | USA
Customer Service: 1-877-242-5676 | info.us@cybex-online.com

CANADA

Goodbaby Canada Inc.
2 Robert Speck Parkway, Suite 750 | Mississauga, ON L4Z 1H8
Customer Service: 1-877-242-5676 | info.us@cybex-online.com

www.cybex-online.com

