























 **cybex**  
GOLD

















**EEZY S<sub>2</sub><sup>+</sup>**







	Preparing the buggy	11
	Using the sun canopy	13
	Using the bumper bar	14
	Using the brake	15
	Adjusting the seat position	16
	Adjusting the leg rest	17
	Using the harness system	18
	Folding	22









	Using the swivel locks	22
	Removing the wheels	23
	Using the rain cover	23
	Attaching the infant car seat	24
	Attaching the cot	26
	Removing the cover	30

	Vorbereitung des Buggies	11
	Verwendung des Sonnenverdeckes	13
	Verwendung des Schutzbügels	14
	Verwendung der Bremse	15
	Einstellung der Rückenlehne	16
	Einstellung der Beinauflage	17
	Verwendung des Gurtsystems	18
	Faltung	22







	Feststellen der Vorderräder	22
	Abnehmen der Räder	23
	Verwendung des Regenverdecks	23
	Anbringen der Babyschale	24
	Anbringen des Kinderwagenaufsatzes	26
	Abnehmen der Bezüge	30

	Préparation du poussette	11
	Utilisation de la capote pare-soleil XXL	13
	Utilisation du garde-corps	14
	Utilisation du frein	15
	Réglage du dossier	16
	Réglage du repose-pieds	17
	Utilisation du harnais	18
	Pliage	22

	Utilisation du verrou de rotation	22
	Retrait des roues	23
	Utilisation de l'habillage pluie	23
	Installation des adaptateurs pour coque	24
	Attacher la nacelle	26
	Retirer la housse	30

	Preparación de la silla de paseo	11
	Uso de la capota solar XXL	13
	Uso de la barra apoyabrazos	14
	Uso del freno	15
	Ajuste del respaldo	16
	Ajuste del reposapiés	17
	Uso del sistema de arneses	18
	Plegado	22



	Uso del bloqueo de dirección de las ruedas delanteras	22
	Extracción de las ruedas	23
	Utilización de la burbuja de lluvia	23
	Colocación del adaptador del portabebés	24
	Colocación del capazo	26
	Extracción de las cubiertas	30

tutorial video  
Videoanleitung  
tutoriel vidéo  
video tutorial



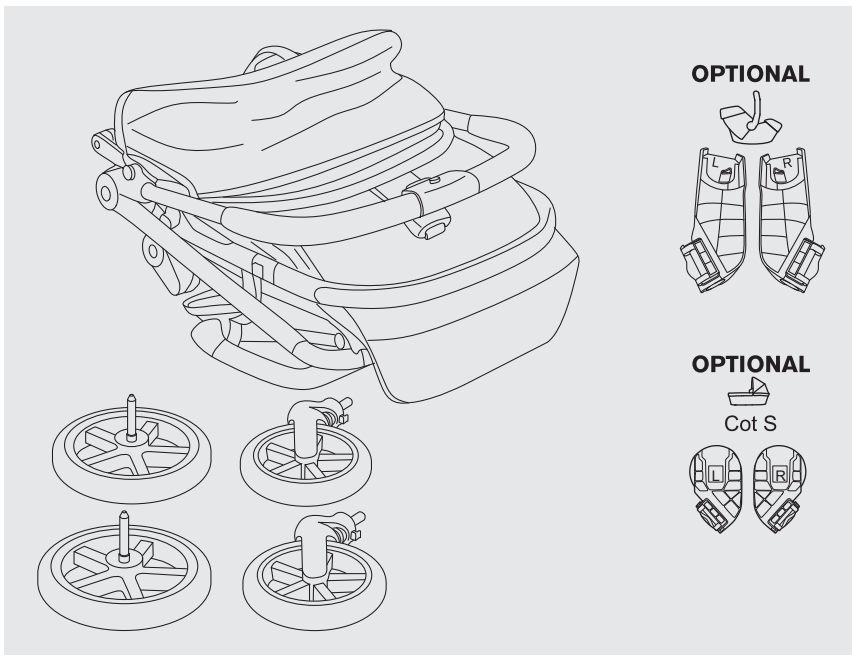

1

**OPTIONAL**

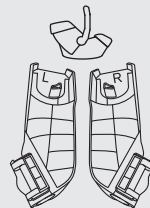

**OPTIONAL**

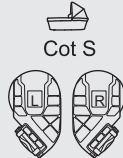

Cot S

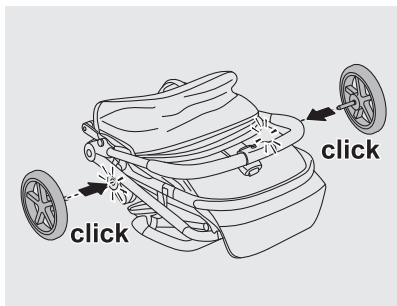

2

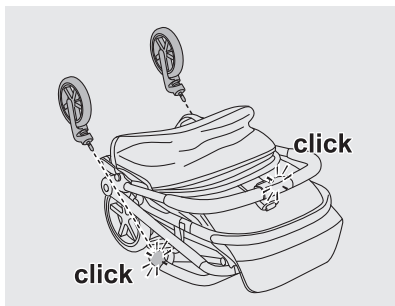

3

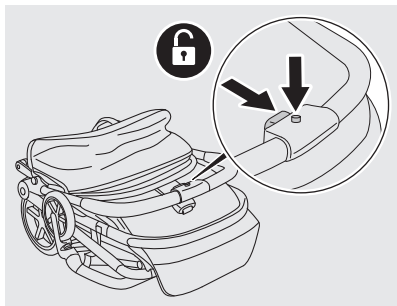

4

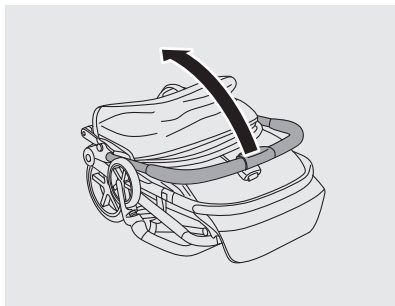

5

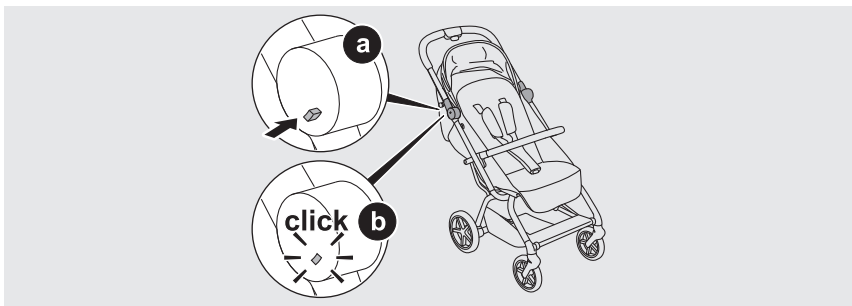

1



2

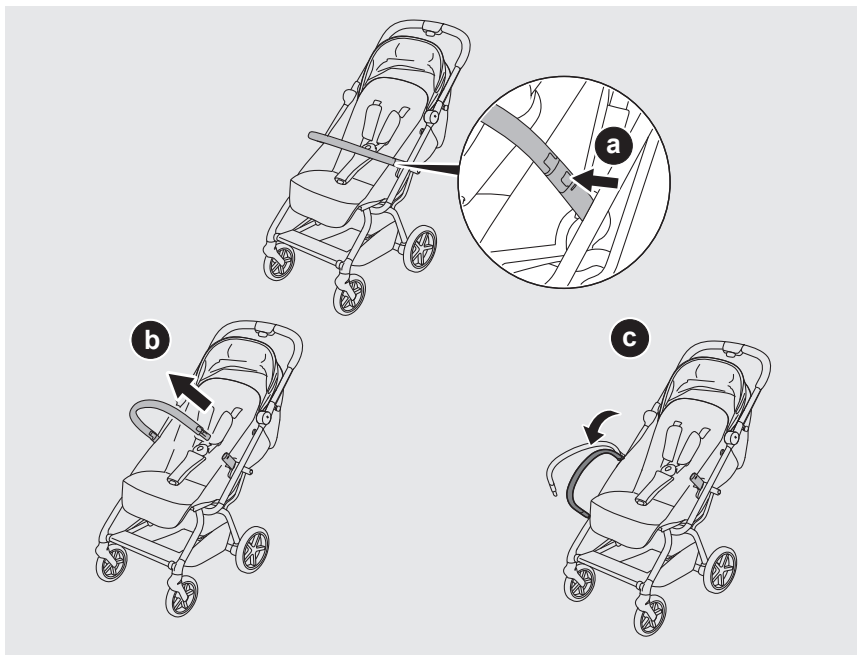

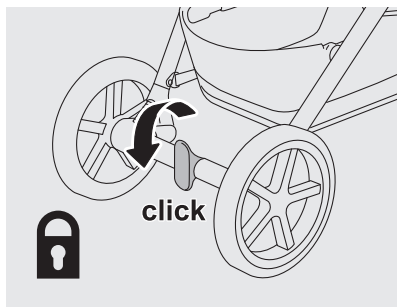

1

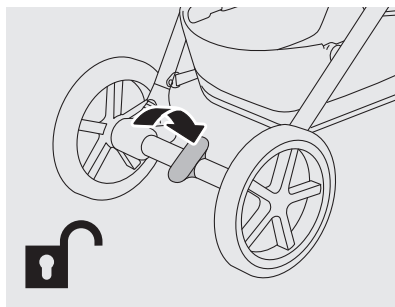

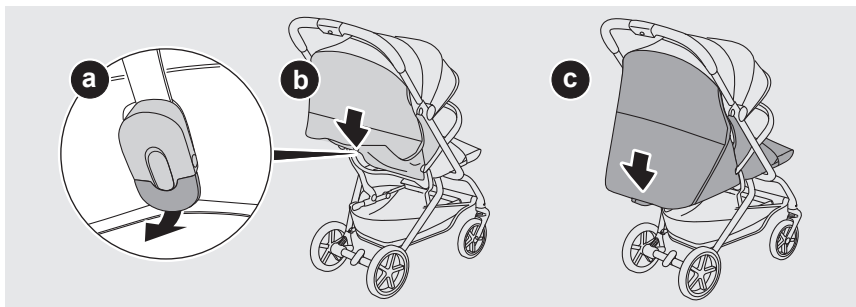

1

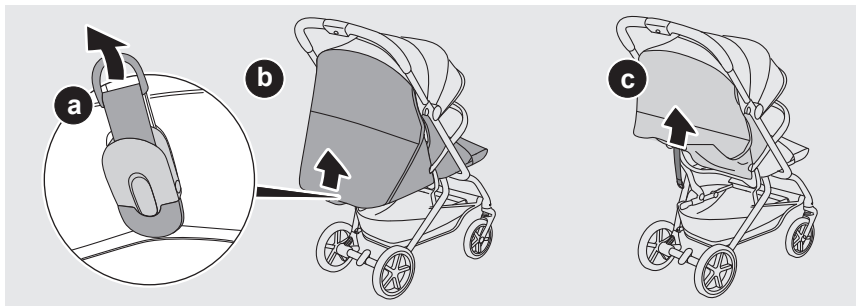

2



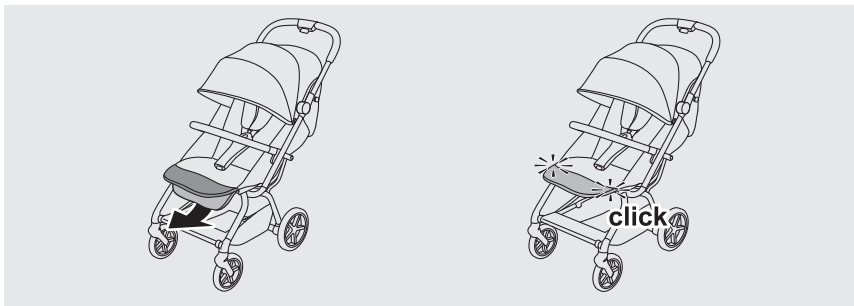

1

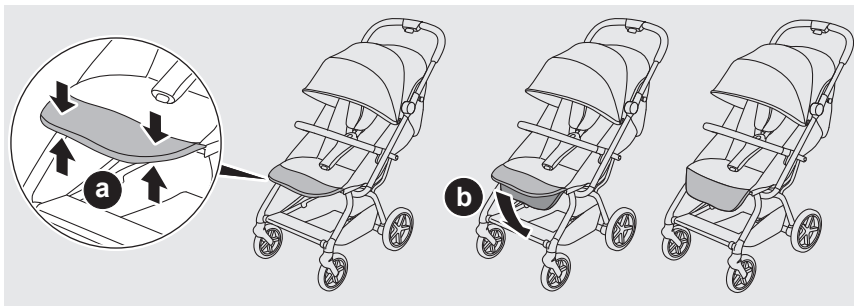

2



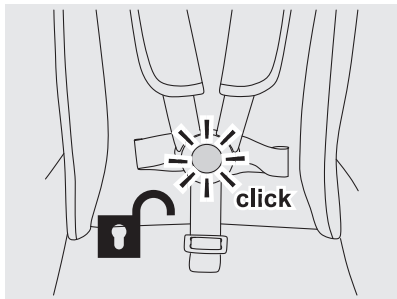

1

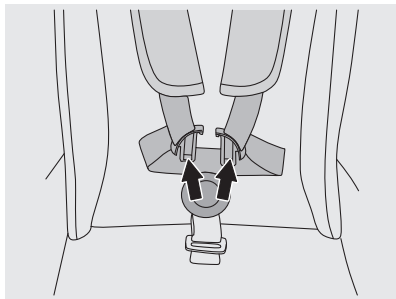

2

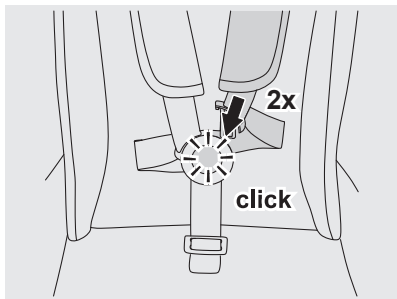

3

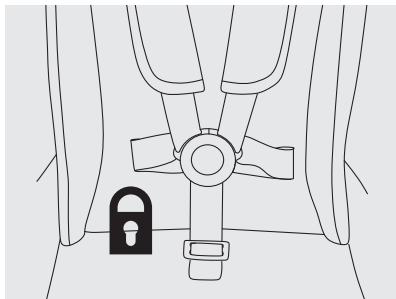

4

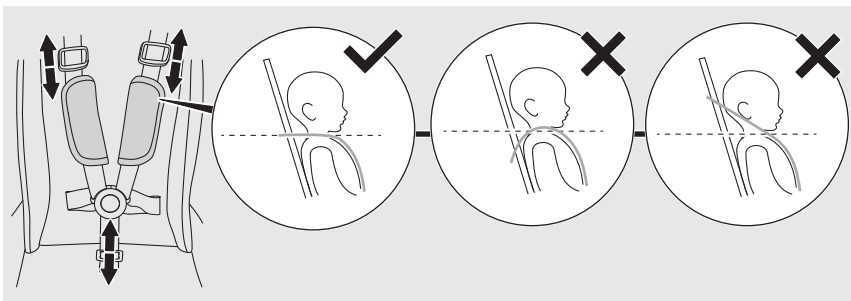

5

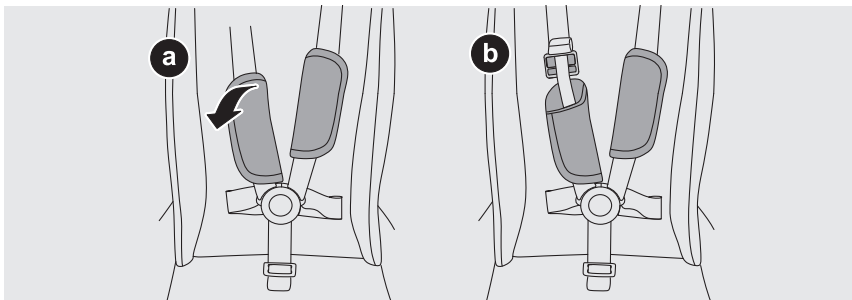

6



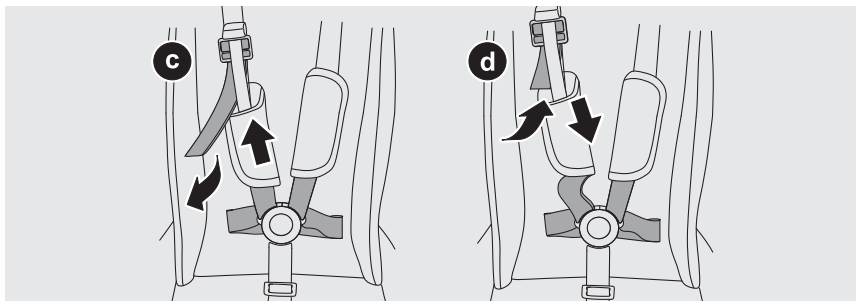

7

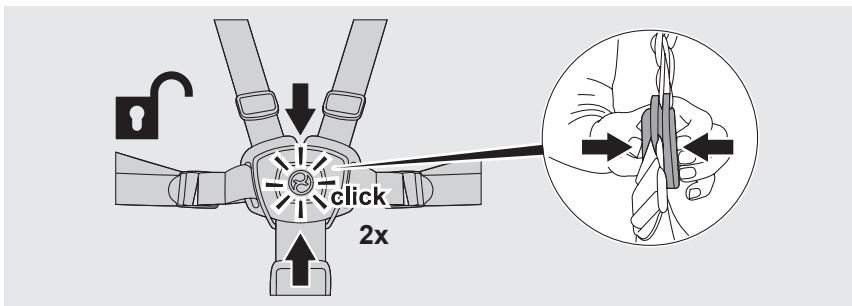

1

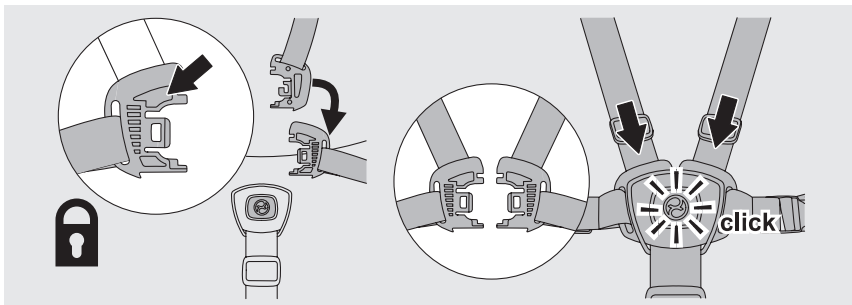

2

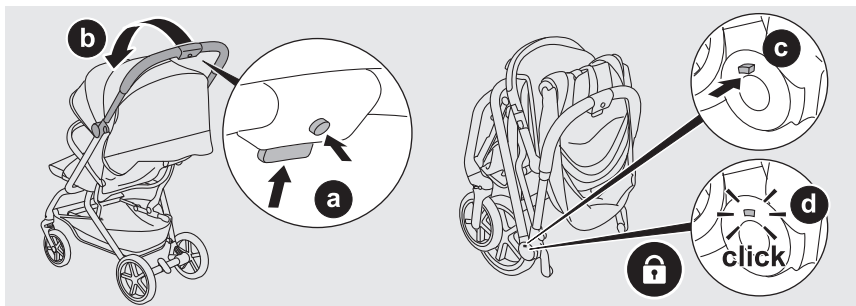

1

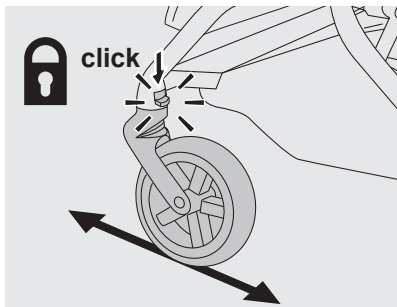

1

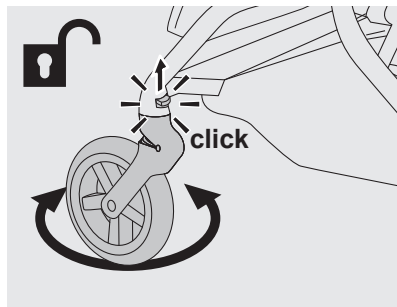

2

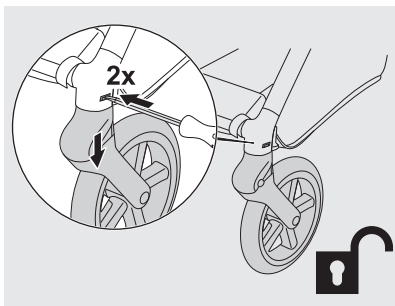

1

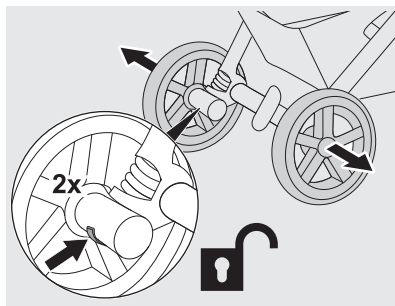

2



1



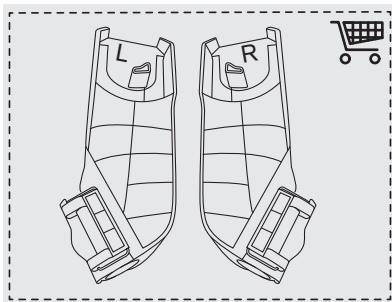

1

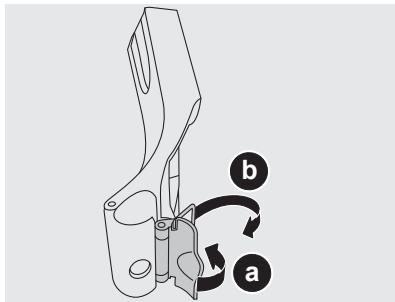

2

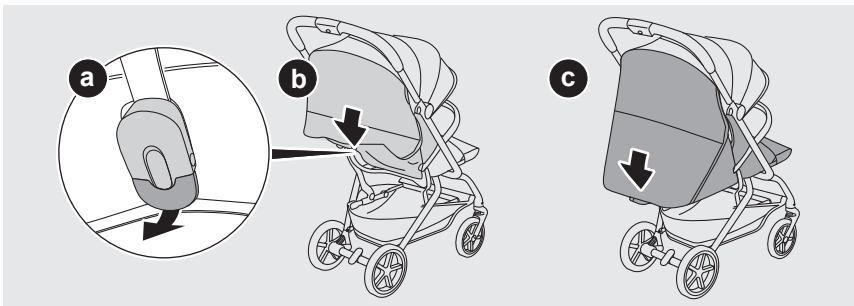

3



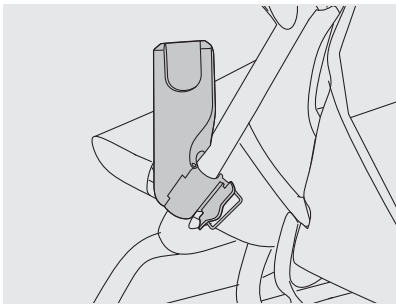

4

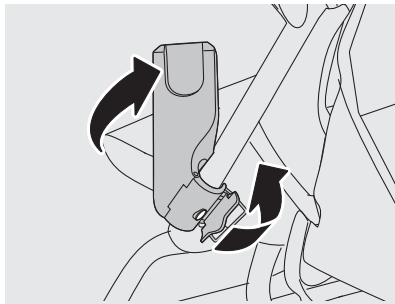

5

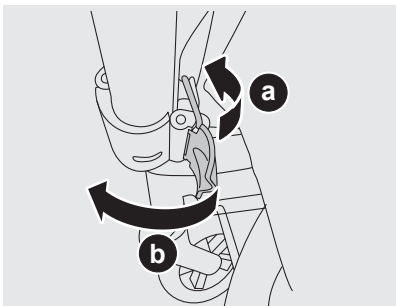

6



7

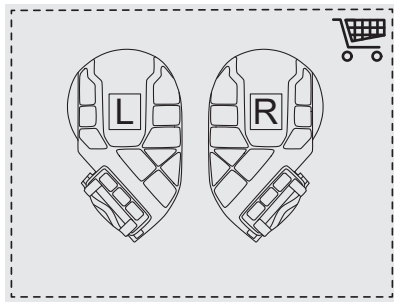

1

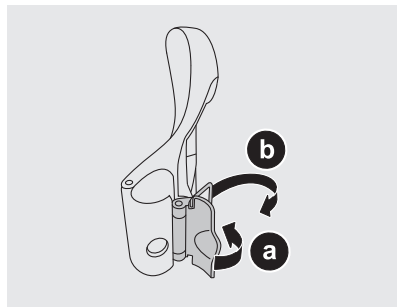

2

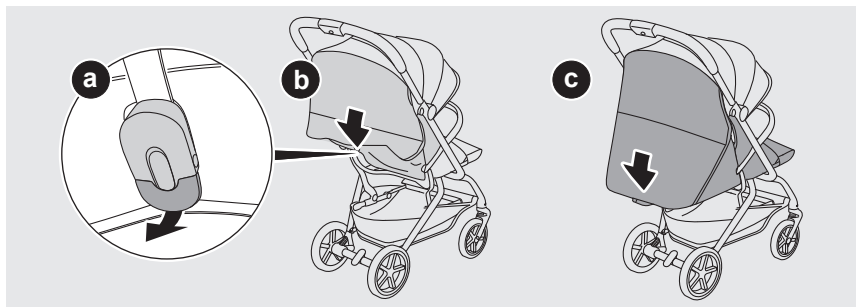

3



4



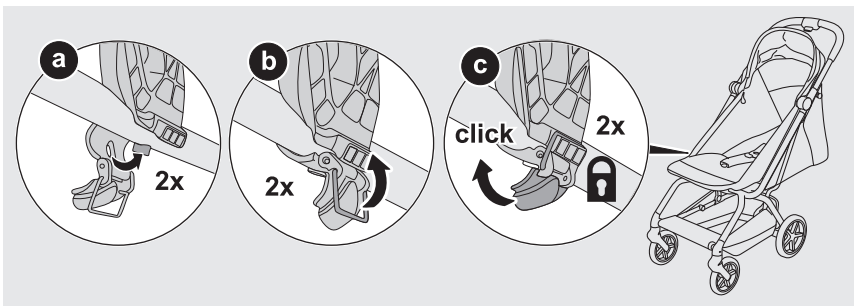

5



6

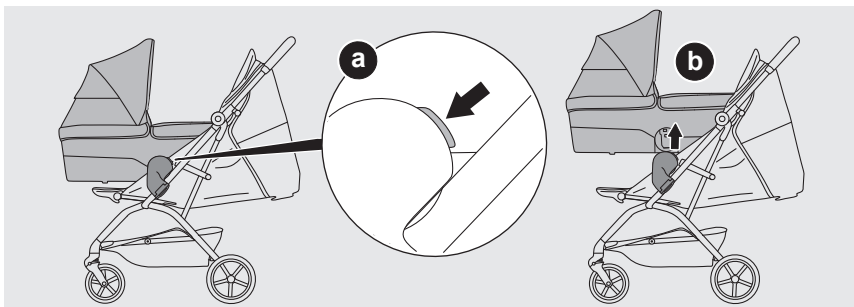

7

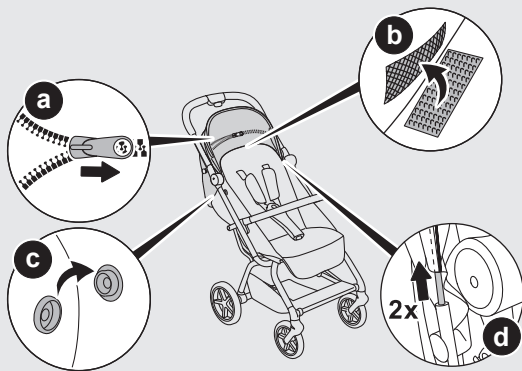

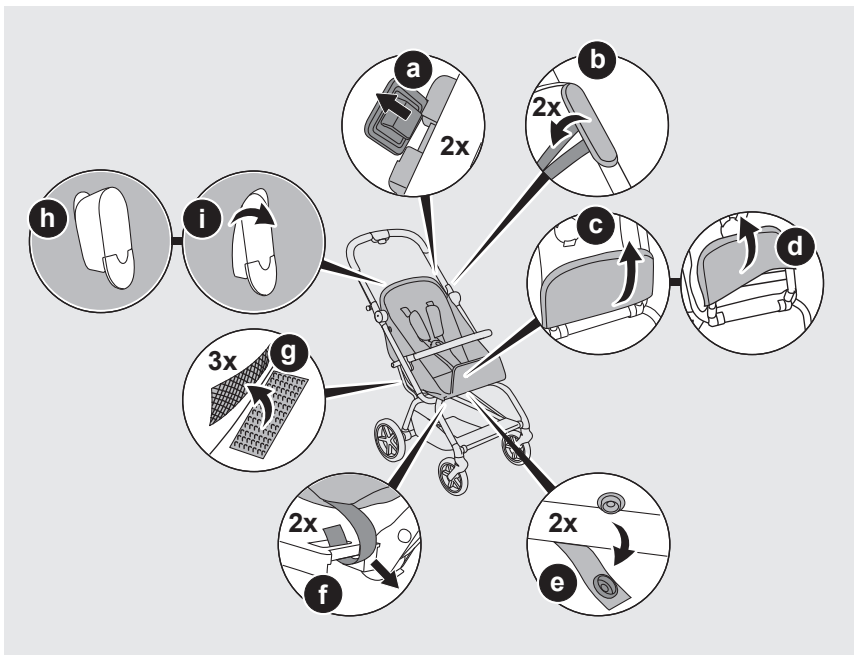

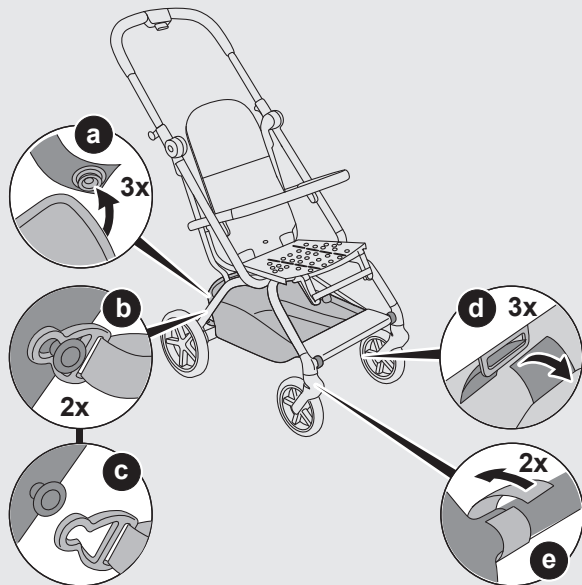



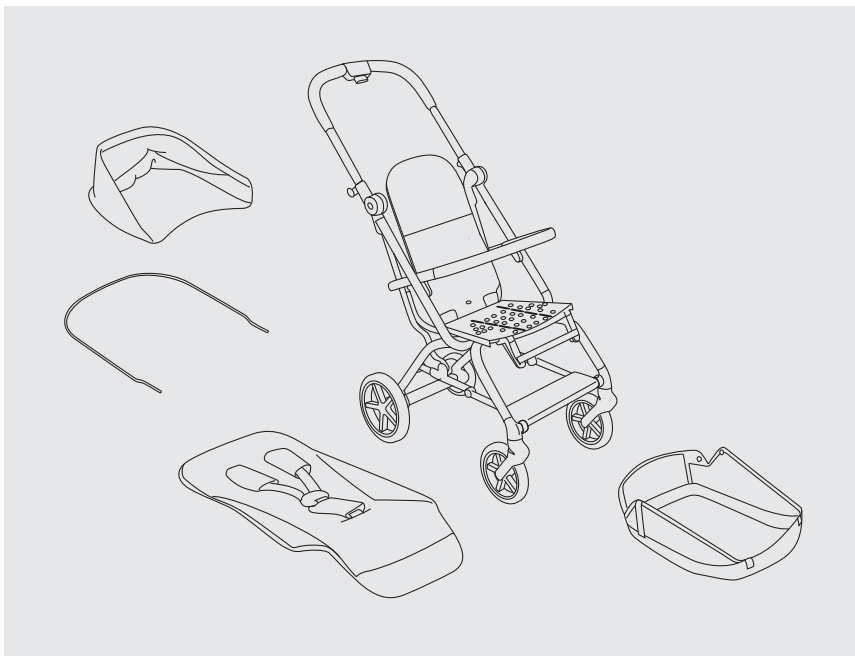







CYBEX GmbH  
Riedingerstr. 18 | 95448 Bayreuth | Germany  
+49 (0) 921-78 511-0 | [info@cybex-online.com](mailto:info@cybex-online.com)  
[www.cybex-online.com](http://www.cybex-online.com)

